

Operation Manual

INKJET PRINTER

JV100-160

Cartridge-ink model

Operation Manual

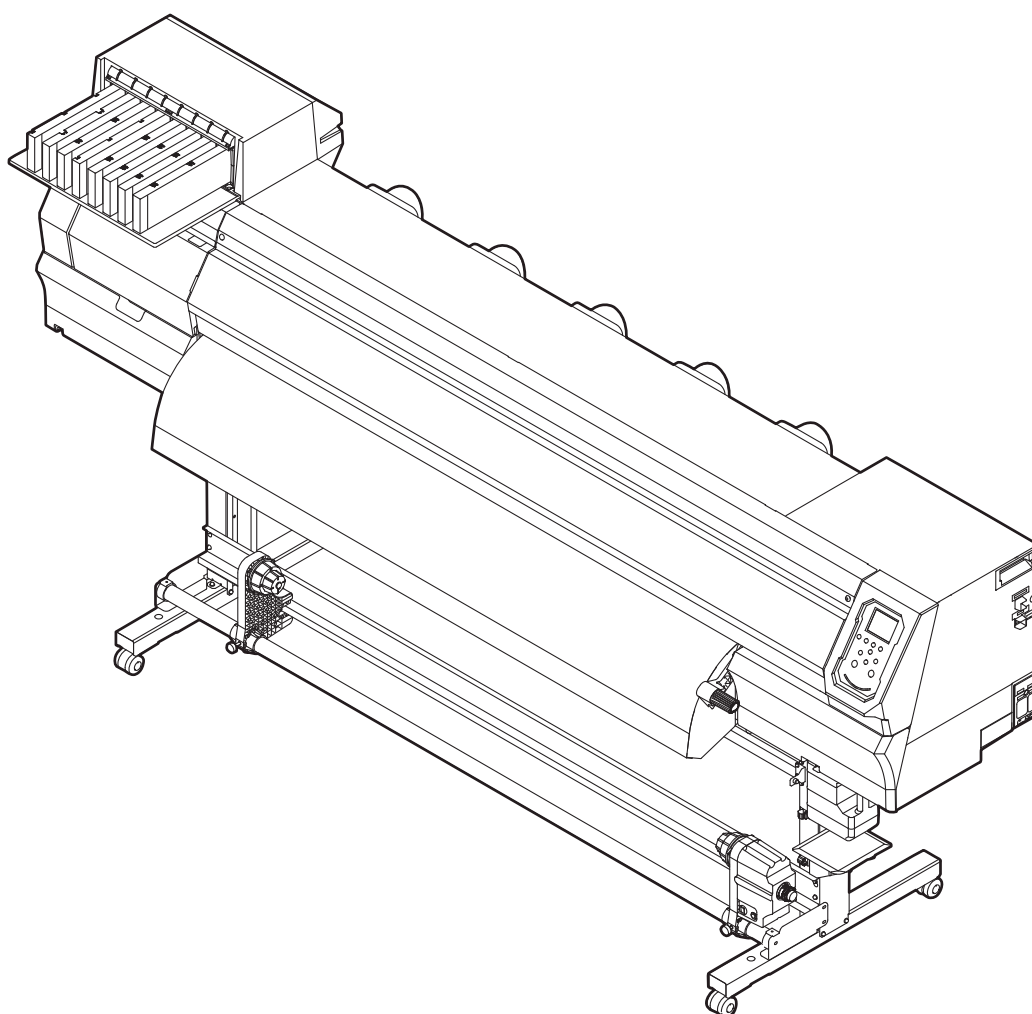

You can also download the latest manual from official website.

MIMAKI ENGINEERING CO., LTD.

<https://mimaki.com/>

D203528-14
Original instructions

TABLE OF CONTENTS

Introduction	5
To ensure safe use	7
Symbols	7
Usage Precautions	8
Ink or any Other Liquid Used with the Machine	12
Ink Specifications	13
Restrictions concerning the product	13
Installation Precautions.....	14
Installation Space	15
When Relocating This Machine	15
Safety Interlocks	16
Warning Label.....	17

Chapter 1 Before Use

1.1 Part Names and Functions	20
Front	20
Rear and Right Side View.....	21
Carriage	22
Capping station.....	22
Pinch Rollers and Grit Rollers.....	22
Platen.....	23
Ink status lamp.....	23
Media sensor	24
Power supply switch	24
Operating panel	26
1.2 Connecting the Power Cable	30
Turning On the Power.....	30
Turning Off the Power.....	31
1.3 Connecting a PC to the Product	32
Using a USB Cable.....	32
Using a LAN Cable	32
1.4 System Configuration	34
Installing Mimaki Driver.....	35
Installing RIP Software	35
Obtaining Color Profiles.....	35
Setting Up RIP Software.....	36
1.5 Ink Replacement Method.....	38
When Ink Level Low or Ink Near End is displayed	38
When Ink End is Displayed.....	39
Replacing Ink	40

Chapter 2 Printing

2.1 Print Process	46
2.2 Adjusting Print Head Height.....	49

2.3 Loading the Media	51
Media	51
Take-up unit.....	51
Loading the Roll Media	53
2.4 Setting the Heater Temperature	57
2.5 Test Printing.....	58
Changing the Layout Direction for Test Printing	58
Printing Defects	59
2.6 Head Cleaning	60
2.7 Feed Correction	61
Feed Correction Procedure	61
2.8 Correcting the Drop Position.....	63
Drop Position Correction Procedure	63
2.9 Preparing RIP Data.....	65
2.10 Printing RIP Data	67
Changing the Origin.....	67
Starting Printing	67
Stopping Printing (Data Clear).....	68
2.11 Cutting the Media.....	69

Chapter 3 Settings

3.1 Setup Menu	72
Changing the name of a setting type	74
3.2 Maintenance menu	75
Registering nozzle recovery	76
3.3 Machine setup menu	79
Registering and Correcting a 600 ml Ink Cartridge.....	82
Event Email Function Settings.....	84
3.4 Nozzle check menu	86
3.5 Information menu.....	87

Chapter 4 Maintenance

4.1 Maintenance Precautions	90
-----------------------------------	----

4.2 Maintenance Procedure.....	91
Maintenance Items and Timing.....	91
Ink Maintenance	91
Wiper Cleaning	92
Cap Rubber Cleaning	93
NCU Cleaning.....	94
Carriage Underside Cleaning	95
Automatic Correction Sensor (DAS) Cleaning.....	96
Ink Discharge Channel Cleaning	97
Media Sensor Cleaning	98
Media Holder Cleaning	98
Platen Cleaning	99
Cover (Exterior) Cleaning	100
When Not in Use for Extended Periods	100
4.3 Consumable Item Replacement	103
Wiper Replacement	103
Wiper Cleaner Replacement.....	104
Cap Replacement.....	105
Cap Absorber Replacement	106
Blowing Fan Filter Replacement.....	108
Pinch Roller Replacement	108
Media Holder Replacement	109
Media Cutter Replacement.....	111
Waste Ink Tank Replacement.....	113

Chapter 5 Troubleshooting

5.1 Troubleshooting	118
The power does not turn on.....	118
Printing is not possible.....	118
The media jams or the media is dirty.....	118
Image defects occur.....	119
The heater temperature does not rise to the specified value.....	121
The ink has leaked.....	121
5.2 Problems indicated by messages	122
Warning messages	122
Ink error	124
Error messages	125
SYSTEM HALT	130

Chapter 6 Appendix

6.1 Specifications.....	132
6.2 About the Relay Box.....	135
6.3 Drying Fan Unit (OPT-J0351).....	136
6.4 LICENSE Library	137

Introduction

Thank you for purchasing the Inkjet printer JV100-160.

Read this operating manual ("this document" hereinafter) thoroughly and make sure you understand its contents to ensure safe and correct use of the product.

Please note that the illustrations contained in this manual are intended to show functions, procedures, or operations and may sometimes differ slightly from the actual machine.

Adobe, the Adobe logo, Acrobat, Illustrator, Photoshop, and PostScript are the trademarks or registered trademarks of Adobe Incorporated in the United States and other countries.

RasterLink is the trademark or registered trademark of MIMAKI ENGINEERING CO., LTD. in Japan and in other countries.

Other company and product names mentioned herein are the trademarks or registered trademarks of the respective companies in Japan and in other countries.

Unauthorized reproduction of any portion of this document is strictly prohibited.

© 2020 MIMAKI ENGINEERING Co., Ltd.

● DISCLAIMERS

- MIMAKI ENGINEERING ACCEPTS NO LIABILITY FOR DAMAGES ARISING DIRECTLY OR INDIRECTLY FROM THE USE OF THE JV100-160 ("THIS MACHINE" HEREINAFTER), WHETHER OR NOT THE PRODUCT IS FAULTY. MIMAKI ENGINEERING REJECTS ALL LIABILITY FOR DAMAGES, DIRECT OR INDIRECT, RESULTING FROM THE USE OF THIS MACHINE.
- MIMAKI ENGINEERING REJECTS ALL LIABILITY FOR DAMAGES, DIRECT OR INDIRECT, ATTRIBUTABLE TO MATERIALS CREATED WHILE USING THIS MACHINE.
- USING THIS MACHINE IN CONJUNCTION WITH DEVICES OTHER THAN THOSE RECOMMENDED BY MIMAKI ENGINEERING MAY RESULT IN FIRE OR ACCIDENTS. SUCH INCIDENTS ARE NOT COVERED BY THE PRODUCT WARRANTY. MIMAKI ENGINEERING REJECTS ALL LIABILITY FOR DAMAGES, DIRECT OR INDIRECT, ARISING FROM SUCH INCIDENTS.
- USE ONLY GENUINE MIMAKI ENGINEERING INK AND MAINTENANCE LIQUID. USE OF OTHER PRODUCTS MAY RESULT IN FAILURES OR REDUCE PRINT QUALITY. SUCH INCIDENTS ARE NOT COVERED BY THE PRODUCT WARRANTY. MIMAKI ENGINEERING REJECTS ALL LIABILITY FOR DAMAGES, DIRECT OR INDIRECT, ARISING FROM SUCH INCIDENTS.
- DO NOT ATTEMPT TO REFILL THE INK PACKS WITH UNAUTHORIZED INK. SUCH INCIDENTS ARE NOT COVERED BY THE PRODUCT WARRANTY. MIMAKI ENGINEERING REJECTS ALL LIABILITY FOR DAMAGES, DIRECT OR INDIRECT, ARISING FROM SUCH INCIDENTS.

● TV and radio interference



- This product emits high-frequency electromagnetic radiation while operating. Under certain circumstances, this may result in TV or radio interference. We make no guarantee that this machine will not affect special radio or TV equipment.

If radio or TV interference occurs, check the radio or TV reception after turning off this machine. If the interference disappears when the power is turned off, this machine is likely to be the cause of the interference.

Try any of the following solutions or combinations of these solutions:

- Change the orientation of the TV or radio antenna to find a position where interference does not occur.
- Move the TV or radio away from this machine.
- Plug the TV or radio into a power outlet on a power circuit other than the power circuit to which this machine is connected.

● FCC (Federal Communications Commission) regulations

This product has been tested and certified to comply with restrictions applying to Class A digital devices under Part 15 of the FCC regulations. These restrictions are designed to provide suitable protection from harmful interference when the printer is used in commercial environments.

This product may generate, use, or emit radio frequency energy and may cause harmful interference with radio communications if not installed or used in accordance with the operating manual.

Use of this product in residential areas may cause harmful interference. If so, the user is responsible for rectifying such interference.











- Use only the cables recommended by Mimaki Engineering when connecting to this product. Use of other cables may cause the product to exceed the restrictions stipulated by FCC regulations. To maintain compliance with FCC regulations, use the cables recommended by Mimaki Engineering.
-

To ensure safe use

Symbols

In this manual, the symbols indicate and explain precautions. Make sure you fully understand the meaning of each symbol and use the machine safely and correctly.

Explanation		
 WARNING	Warning	Indicates a potential hazard that may result in death or serious injury if handled improperly or if instructions are disregarded.
 CAUTION	Caution	Indicates a potential hazard that may result in minor or moderate injury if handled improperly or if instructions are disregarded.
 NOTICE	Notice	Indicates a potential hazard that may result in property damage if handled improperly or if instructions are disregarded.
	Warning sign	Indicates something that requires attention. Warning specifics are drawn inside the symbol.
	Mandatory action sign	Indicates an action that must be carried out. The specifics of the mandatory action are drawn inside the symbol.
	Prohibition sign	Indicates a prohibited action. The specifics of the prohibited action are drawn inside the symbol.
 Important!	Important	Indicates important information related to use of this machine.
	Tip	Indicates useful reference information.
	Reference information	Indicates the corresponding page for related information.

Usage Precautions

● In the event of abnormal conditions

WARNING



- In the event of abnormal conditions such as smoke or unusual odor, turn off the main power immediately and unplug the power cable. Continuing to use the product under these conditions may result in failure, electric shock, or fire. Once you have confirmed that smoke is no longer being emitted, contact your local dealer or our service office. Never attempt to repair the product yourself. Doing so is hazardous.

CAUTION



- Immediately wipe off any ink, maintenance liquid, waste ink, or other liquid used with the product that comes into contact with your skin. Then wash using soap, and rinse with plenty of water. Failure to wash off ink may result in skin inflammation. If your skin becomes irritated or painful, seek medical attention immediately.
- If ink, maintenance liquid, waste ink, or any other liquid used in the product comes into contact with your eyes, rinse immediately with plenty of clean water. Rinse for at least 15 minutes. If you wear contact lenses and they can be easily removed, remove after rinsing for at least 15 minutes with clean water. Be sure to also rinse the undersides of your eyelids. Failure to rinse off ink may result in blindness or impaired vision. If your eyes become irritated or painful, seek medical attention immediately.
- If ink, maintenance liquid, waste ink, or any other liquid used in the product enters your mouth or is swallowed, gargle with water immediately. Do not induce vomiting. Seek medical attention promptly. Inducing vomiting may cause liquid to enter the airway.
- If a large amount of vapor is inhaled, move to a well-ventilated area, keep warm, and rest in a posture that allows easy breathing. If the condition does not improve, seek medical attention promptly.

NOTICE



- If an ink leak occurs, turn off the main power immediately and unplug the power cable. Then, contact your local dealer or our service office.

● Power supply precautions

⚠ WARNING



- Use the power cable provided. Otherwise there is a risk of failure, electric shock, or fire. Do not use the power cable with other electronic devices.
- Always grasp the plug when unplugging the power cable. Pulling on the power cable itself may damage the cable and result in failure, electric shock, or fire.
- Do not use the power plug with dust on it. Otherwise there is a risk of failure, electric shock, or fire.
- Avoid touching the blade of the power plug with a metal object. Otherwise there is a risk of failure, electric shock, or fire.
- Do not attempt to modify the cable. Avoid damaging the cable. Avoid placing heavy objects on the power cable or pulling on or exposing the cable to heat. Doing so may damage the cable, resulting in electric shock or fire.
- Do not use extension cords or multi-outlet extension cords. Otherwise there is a risk of failure, electric shock, or fire.
- Do not use if the power cable appears to be damaged or the core wire has an exposed or broken core. Otherwise there is a risk of failure, electric shock, or fire.



- Do not handle the power plug with wet hands. There is a risk of electric shock.



- Plug the power cable plug into a grounded power outlet. Otherwise there is a risk of failure, electric shock, or fire.
- When installing electrical outlets, perform grounding work to prevent electric shock. All electrical work (Class C grounding work; formerly Type 3 grounding work) must be handled by a licensed electrician.

NOTICE



- Do not turn off the main power supply. Turning off the main power supply will disable the automatic maintenance function (including nozzle clogging prevention function and ink discharge channel cleaning function). This will increase the risk of print defects (e.g., nozzle clogging, deflection).

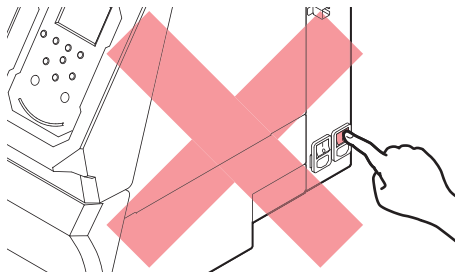

- Use this machine with a power supply that meets specifications.
- Be sure to plug the power cable into a power outlet close to the machine. Insert the power plug blade securely.
- When connecting the power cable, check the input voltage of the power outlet and the capacity of the breaker. Also, connect each cable to a separate power source with an independent breaker. Connecting to power outlets linked with the same breaker may trip the breaker.

● **Caution regarding moving parts**

CAUTION



- Keep parts of the body such as the face and hands away from moving parts. Also keep clothing (e.g., loose clothing and accessories) that may impede work away from the machine. Failure to do so may result in injury.



- Long hair should be tied back. Failure to do so may result in injury.

● **Do not disassemble or repair**

WARNING



- Do not attempt to disassemble or repair this machine. Otherwise there is a risk of failure, electric shock, or fire.

● **Handling the cutter**

CAUTION



- Avoid touching the cutter blade. Failure to do so may result in injury.

● **Heater**

CAUTION



- The heater becomes extremely hot. Do not touch with bare hands.

NOTICE



- Condensation may form on the print head nozzle surface depending on the ambient temperature and humidity. The formation of condensation may cause printing defects (e.g., nozzle clogging or deflection). Perform head cleaning if any printing defects (e.g., nozzle clogging or deflection) occur during printing. ["Head Cleaning"\(P. 60\)](#)
Set the platen heater to a temperature not exceeding 35 °C, and ensure that the ambient temperature is within the permissible operating temperature range (20 °C to 30 °C). ["Installation Precautions"\(P. 14\)](#)

● **Other usage precautions**

WARNING



- Keep children away from this machine.

NOTICE



- Printing may show through from the underside depending on the media type and media storage method after printing (such as the load due to placing flat media that have been rolled up). Perform a test beforehand to check that print does not show through from the underside.

- **Disposing of the product**

⚠ CAUTION

- Please contact your local retailer or service agent.
- When disposing of the product yourself, contact an industrial waste disposal operator or dispose of the product in accordance with local laws and regulations.

Ink or any Other Liquid Used with the Machine

Precautions regarding ink, maintenance liquid, or other liquids used with this machine are indicated on the containers. Thoroughly read them and make sure you understand the contents.

⚠ WARNING



- Take steps to prevent leakage into natural water systems or domestic wastewater. Some constituents are toxic to aquatic life.

⚠ CAUTION



- Be sure to read the safety data sheet (SDS) before use. <https://mimaki.com/supply/sds/>



- Pay close attention to ventilation and be sure to wear safety glasses, gloves, and a mask when handling ink, maintenance liquid, waste ink, or other solutions used with this machine. Leaking ink may adhere to the skin or get into the eyes or mouth.



- Do not subject Ink cartridge to strong shocks or violent shaking. Do not attempt to refill the ink. Leaking ink may adhere to the skin or get into your eyes or mouth.



- Do not disassemble Ink cartridge. Leaking ink may adhere to the skin or get into your eyes or mouth.



- Avoid storing this product in locations accessible to children.



- When disposing of the product, contact an industrial waste disposal operator or dispose of the product in accordance with the local laws and regulations.

NOTICE



- Do not use ink, maintenance liquid, or other liquids used with this machine with other printers. Disregarding this precaution may result in damage to the printer.
- Do not touch the metal parts of the ink IC chip. Static electricity may damage the ink IC chip, and dirt or damage may make the ink IC chip unreadable.



- Store in a low place no higher than 1 m above the floor. Dropping this machine may result in splashing ink.
- Store in sealed containers.
- Store in a cool and dark place.
 - (1) Store ink in an environment where it will not freeze. Note that using thawed ink may affect printing quality due to ink degradation.
 - (2) When moving ink from cold to warm locations, allow to stand for at least three hours before use in the same conditions as the machine.
 - (3) Open the ink before use and use up as quickly as possible. Print quality may degrade if the bottles are left open for extended periods.



- Printing is disabled if a different ink IC chip is used.



- Do not expose ink, maintenance liquid, and other liquids used with the machine to direct sunlight.
- Do not store ink, maintenance liquid, or other liquids used with the machine in environments where cutting fluid or other volatile substances (such as amines or modified amine alcohol) are present in significant quantities. Storage in such places increases the risk of failure or printing defects (e.g., nozzle clogging, deflection).

Ink Specifications

Item		Details
Type		Special solvent ink (MIMAKI product)
Color		Cyan (C) Magenta (M) Yellow (Y) Black (K) Light cyan (Lc) Light magenta (Lm) Light black (Lk) Orange (Or)
Form		Cartridge
Ink capacity		600 ml
Expiration date		As indicated on the ink pack. However, within three months after opening, even before the expiration date
Storage temperature	When stored	10 °C to 35 °C (daily mean temperature) However, not more than 1 month at 30 °C • Ink quality may deteriorate if stored outside these conditions.
	During transportation	1 °C to 40 °C However, not more than 120 hours at 60 °C, and not more than 1 month at 40 °C • Where possible, avoid storing in cold locations below 0 °C and hot locations above 40 °C. • Ink quality may deteriorate if stored outside these conditions.

Restrictions concerning the product

The ink expiration date is indicated on the Ink pack. Expired ink may cause printing defects or alter the color tone. Printing is possible even if the ink has passed its expiration date. Nevertheless, we recommend replacing with new ink or using up as quickly as possible.

Example: When the expiration date is April 2023

- May: Replace with new ink or use up as quickly as possible. Printing is possible.
- June: Replace with new ink or use up as quickly as possible. Printing is possible.
- July: Printing is not possible.



- The message appears on the display.

Installation Precautions

WARNING



- Do not install this machine in environments where flammable substances are present (e.g., gasoline, flammable spray, alcohol, thinner, lacquer, or powder). This machine is not explosion-proof. The product poses a risk of explosion.



- Do not install this machine in locations where open flames are present. The ink may ignite.
- Do not place vases, pot plants, cups, cosmetics, containers of chemicals or water, or small metal objects on top of this machine. There is a risk of failure, electric shock, or fire if liquids or items drop inside the machine.



- Do not install this machine in humid locations or locations where it may be exposed to splashing water. Otherwise there is a risk of failure, electric shock, or fire.



- Avoid installing this machine in locations accessible to children.

CAUTION



- A ventilation system must be provided if this machine is installed in a poorly ventilated area or sealed room.
- Be sure to observe the following points when installing an extractor outlet:
 - (1) The extractor outlet must be installed in accordance with applicable local EHS (environmental, health, and safety) guidelines.
 - (2) If the extractor outlet is fitted with a shutoff valve, the valve must be open when this machine is in use.

NOTICE



- Do not install this machine in locations where dust or powder is present. Failure or printing defects may result (e.g., nozzle clogging, deflection) if dust gets inside this machine.
- Do not install this machine in locations exposed to drafts (e.g., from air conditioning). Disregarding this precaution may result in dust or powder getting inside this machine.
- Do not install this machine in unstable locations or locations subject to vibration. This will increase the risk of failure or printing defects (e.g., nozzle clogging, deflection).
- Do not install this machine in locations exposed to direct sunlight.
- Do not install this machine in locations subject to sudden temperature changes. This will increase the risk of failure or printing defects (e.g., nozzle clogging, deflection).
- Do not install this machine in locations exposed to excessive noise from large machinery.
- Do not install this machine in locations where photographic fixing agents generate vapor or acid gas (e.g., acetic acid, hydrochloric acid) or locations filled with metal working fluids or highly volatile substances (e.g., amines, amine-modified alcohols). Malfunctions or printing defects may result (e.g., nozzle clogging, deflection) as print head ink is more likely to harden under such environments.



- Operating conditions: 20 °C to 30 °C (68 °F to 86 °F), 35 %RH to 65 %RH (no condensation)
- Guaranteed accuracy temperature range: 20 °C to 25 °C (68 °F to 77 °F)

Installation Space

Provide the following space around the machine to allow safe and proper replacement of ink and media:

Item	JV100-160
Width ^{*1}	At least 3,775 mm (2,775 mm)
Depth ^{*1}	At least 2,700 mm (700 mm)
Height ^{*1}	(1,392 mm)
Weight	166 kg

*1. The figures in parentheses indicate machine dimensions.

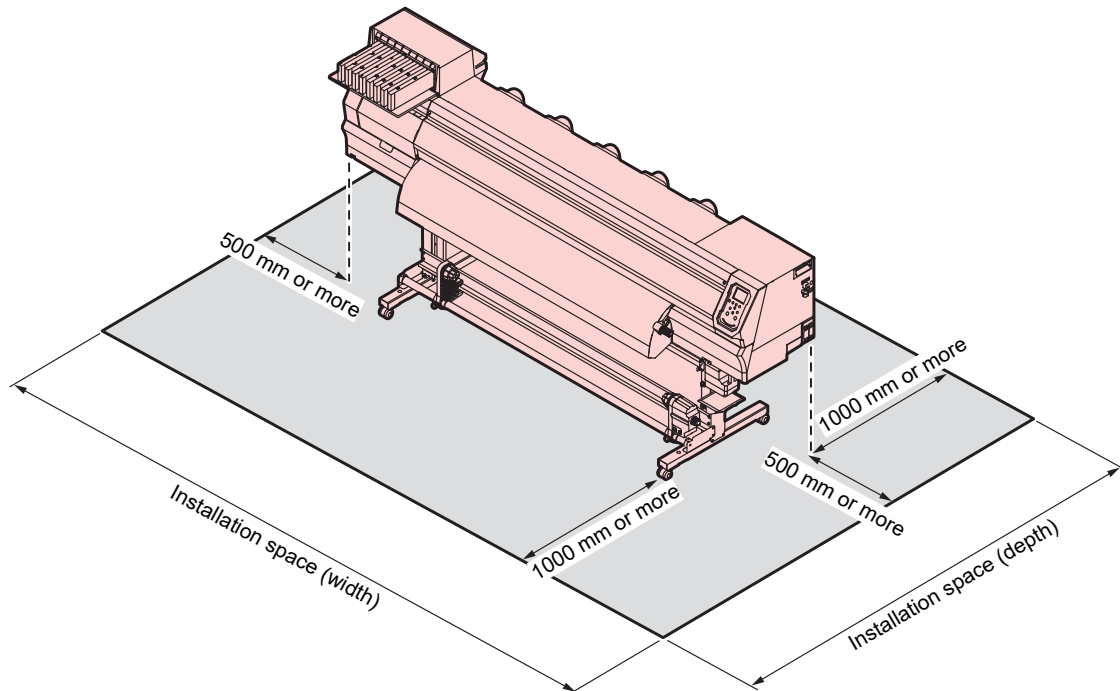

When Relocating This Machine

Contact your local dealer or our service office. Attempting to handle relocation yourself may result in failure or damage.

Safety Interlocks

This machine is equipped with interlocks to ensure safety during use.

Printing will abort if you open the covers while printing is underway. If so, you will need to resend the RIP data.

- Safety interlock locations

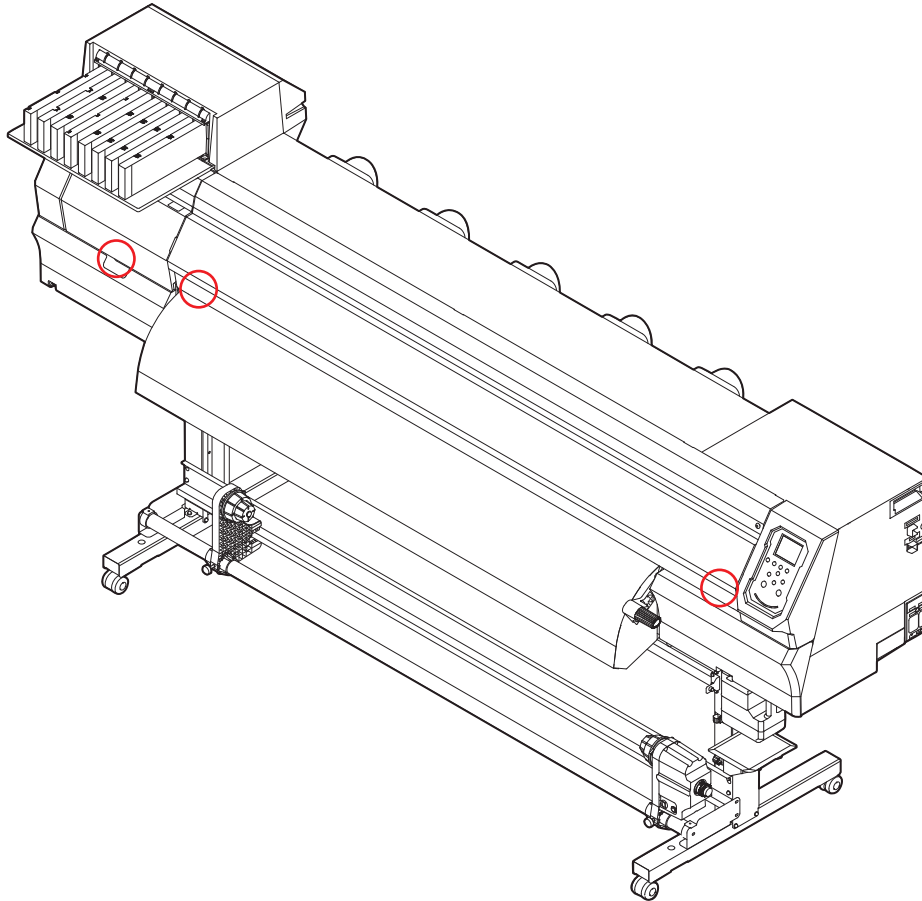







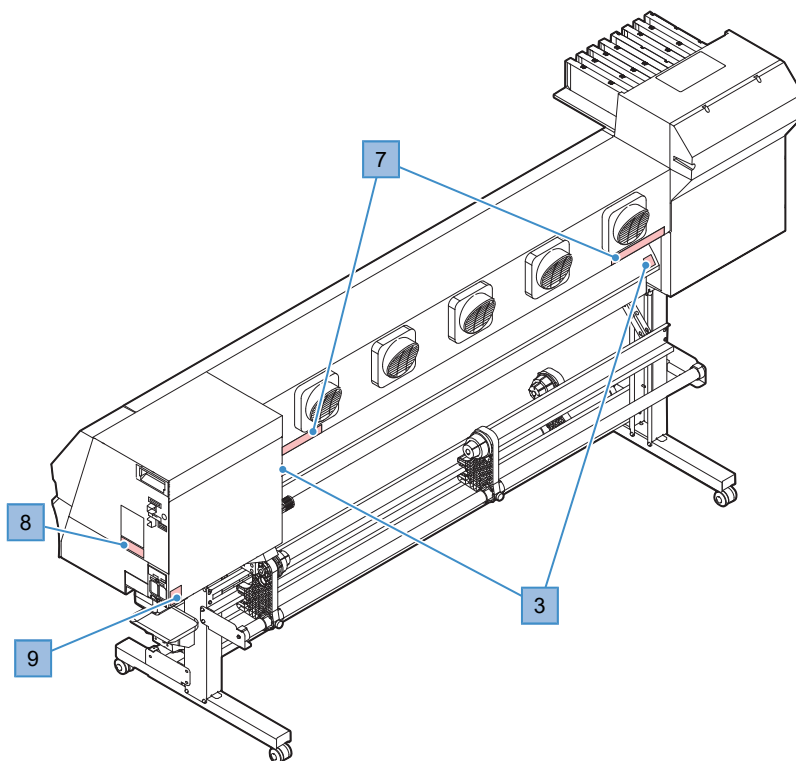
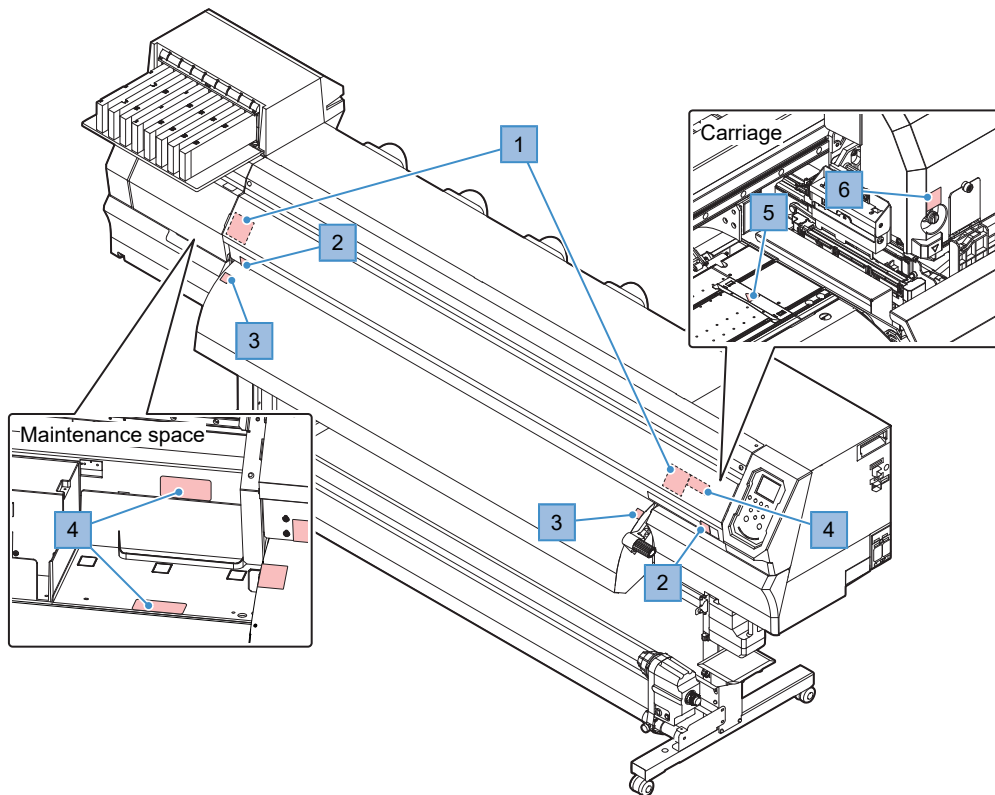

Warning Label

Make sure you fully understand the details indicated on the various warning labels.

If any of the warning labels becomes dirty and illegible or peel off, contact your local dealer or our service office to request new warning labels.

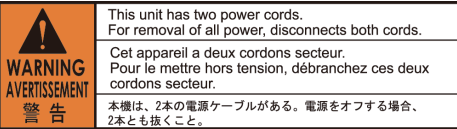

No.	Order code	Label	Details
1	M910931	 <p>CAUTION ATTENTION</p> <p>COVER HAZARD May result in severe injury. When open and close the cover, hold a cover until the end.</p> <p>COUVERCLE-DANGER Peut entraîner de graves blessures. Lors de l'ouverture ou de la fermeture du couvercle, tenir le couvercle jusqu'à la fin.</p> <p>カバー急落下あり 指を挟まると、ケガや骨折の恐れあり。 カバーの開閉は、最後まで手を離さず行ってください。</p> <p>M910931</p>	Beware of opening and closing parts. Injury may result if hands become trapped.
2	M907833		Indicates dangerous moving parts.
3	M903239		Indicates hot parts.
4	M903330		Wear safety glasses and gloves while working.
5	M906144		Indicates hot parts.
6	M903405		Beware of the cutter.
7	M905811		Indicates dangerous moving parts.
8	M906031	 <p>WARNING AVERTISSEMENT 警告</p> <p>This unit has two power cords. For removal of all power, disconnects both cords.</p> <p>Cet appareil a deux cordons secteur. Pour le mettre hors tension, débranchez ces deux cordons secteur.</p> <p>本機は、2本の電源ケーブルがある。電源をオフする場合、2本とも抜くこと。</p>	Describes the power cable.
9	M907935		Indicates dangerous live parts.

Chapter 1 Before Use



This chapter

This chapter describes information essential before use, such as part names.

Part Names and Functions	20	Connecting a PC to the Product	32
Front	20	Using a USB Cable	32
Rear and Right Side View	21	Using a LAN Cable	32
Carriage	22	System Configuration	34
Capping station	22	Installing Mimaki Driver	35
Pinch Rollers and Grit Rollers	22	Installing RIP Software	35
Platen	23	Obtaining Color Profiles	35
Ink status lamp	23	Setting Up RIP Software	36
Media sensor	24	Ink Replacement Method	38
Power supply switch	24	When Ink Level Low or Ink Near End is displayed	38
Operating panel	26	When Ink End is Displayed	39
Connecting the Power Cable	30	Replacing Ink	40
Turning On the Power	30		
Turning Off the Power	31		

1.1 Part Names and Functions

Front

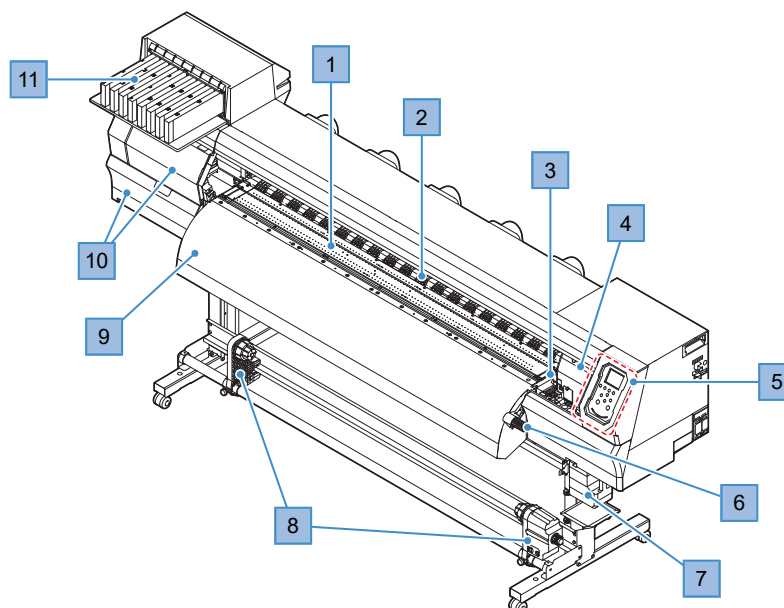

No.	Name	Outline
1	Platen	Print area. The platen is fitted with a heater. Helps prevent ink bleeding. Adjust the temperature setting to suit the type of media used. "Platen"(P. 23) "Setting the Heater Temperature"(P. 57)
2	Pinch rollers Grit rollers	The pinch rollers and grit rollers are used to grip and feed the media. "Pinch Rollers and Grit Rollers"(P. 22)
3	Capping station	Includes caps, wipers, and an NCU for monitoring print head nozzle conditions. "Capping station"(P. 22)
4	Carriage	Consists of a print head, the jam sensor, and the media cutter. "Carriage"(P. 22)
5	Operating panel	Includes operating keys and displays indicating various settings and other items. "Operating panel"(P. 26)
6	Clamp lever (front)	Lowering the clamp lever secures the media. Raising the clamp lever releases the media.
7	Waste ink tank	Container for waste ink. "Waste Ink Tank Replacement"(P. 113)
8	Take-up unit	Automatically roll up the roll media after printing. "Take-up unit"(P. 51)
9	Post-heater	Allows ink to dry after printing. Adjust the temperature setting to suit the type of media used. "Setting the Heater Temperature"(P. 57)
10	Maintenance covers	Open the cover to perform maintenance. Printing and automatic maintenance are not possible while the covers are open.
11	Ink supply unit	The Ink cartridge is inserted here to supply ink to the print head. "Ink Replacement Method"(P. 38)

Rear and Right Side View

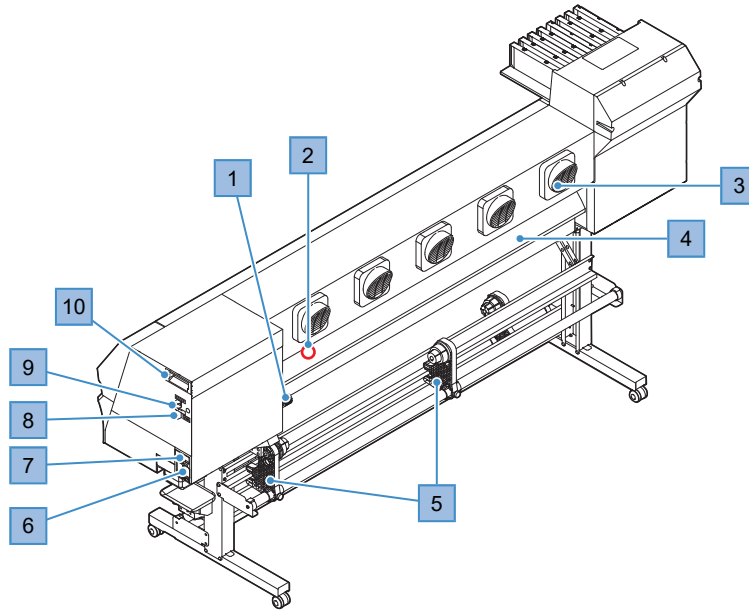

No.	Name	Outline
1	Clamp lever (rear)	Linked to the clamp lever at the front.
2	Media sensor	Detects whether media is present. ☞ "Media sensor"(P. 24)
3	Blowing fan	Blows air to dry ink after printing.
4	Preheater	Preheats the media before printing to suppress rapid temperature change. Adjust the temperature setting to suit the type of media used. ☞ "Setting the Heater Temperature"(P. 57)
5	Feeding unit	Holds the roll media before printing. Compatible with 2-inch and 3-inch paper rolls
6	AC inlet	The inlet at the front (INLET2) is for the heater and the inlet at the rear (INLET1) is for the machine. Used to connect the power cable (provided). ☞ "Connecting the Power Cable"(P. 30)
7	Main power supply switch	The power supplies at the front and rear are for the heater and the machine respectively. To prevent print defects attributable to the print head (e.g., nozzle clogging, deflection), do not turn off the main power supply. ☞ "Turning On the Power"(P. 30) ☞ "Turning Off the Power"(P. 31)
8	LAN port	Used when using the network function. ☞ "Using a LAN Cable"(P. 32)
9	USB port	Connects to PC via a USB interface cable. ☞ "Using a USB Cable"(P. 32)
10	Maintenance liquid cartridge	Used to automatically feed maintenance liquid to the cap, to drip liquid on to the wiper to prevent ink solidification, and to prevent ink solidifying inside the ink discharge channel during maintenance.

Carriage

The carriage includes a print head for ejecting ink, and a jam sensor for stopping the carriage when media clogs. Printing occurs as ink is ejected while traversing left and right.

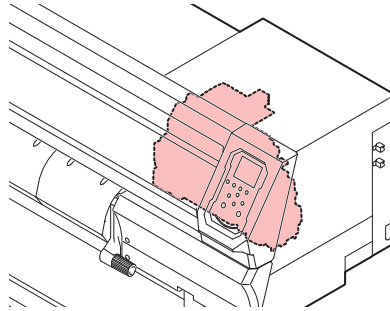

Capping station

The capping station includes caps for keeping the print head nozzle surface from drying out, a wiper required for print head maintenance, and an NCU for monitoring print head nozzle conditions.

The NCU (Nozzle Check Unit) automatically checks whether the nozzle is clogged. Setting various functions enables automatic print head cleaning or printing using other nozzles. (P. 86) "Nozzle check menu" (P. 86) "Registering nozzle recovery" (P. 76)

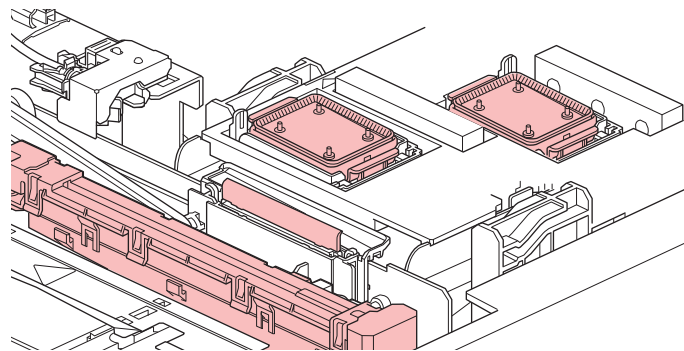

Pinch Rollers and Grit Rollers

The pinch rollers and grit rollers are used to grip and feed the media.

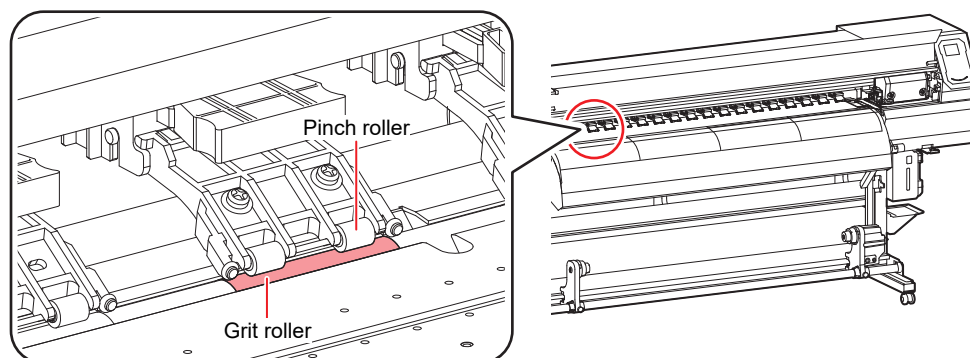

- When this product is not in use, raise the clamp lever to separate the pinch rollers from the grit rollers. Leaving the pinch rollers in the lowered position for an extended period of time may cause the pinch rollers to become deformed. Deformation of the pinch rollers may prevent the media from being fed correctly.



- Attach the clamp changeover sliders to the pinch rollers at the left and right-hand ends of the media. The pinch rollers can be raised by attaching clamp changeover sliders. This prevents gripping the left and right-hand ends of the media for consistent feeding.

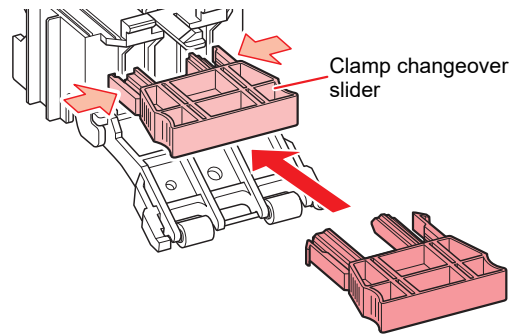

Platen

The platen features a large number of holes used to secure the media under vacuum pressure. This also features a cutting slot for cutting the media.

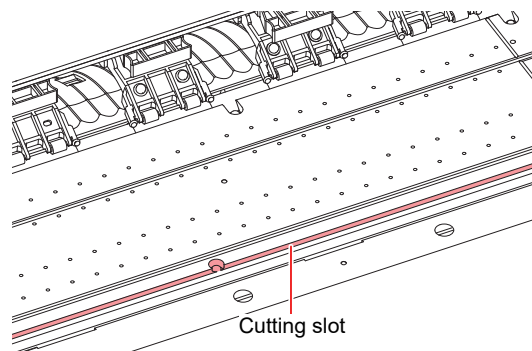

Ink status lamp

You can check the status of the ink by looking at the lamp on the ink supply unit.

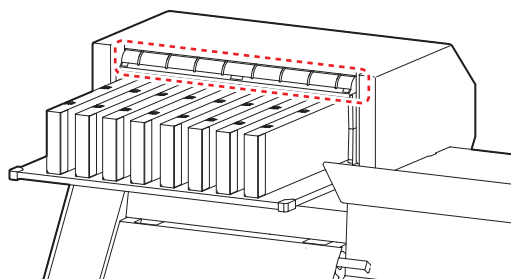

Color	Status	Outline
-	Off	No error
Blue	Illuminated	Ink is being supplied (no error)
Yellow	Illuminated Flashing	One of the following errors has occurred: Printing is possible. <ul style="list-style-type: none"> • INK NEAR-END • Ink expired (1 months passed)
Red	Illuminated	One of the following errors has occurred: Printing is not possible. <ul style="list-style-type: none"> • INK END

Color	Status	Outline
		<ul style="list-style-type: none"> The ink IC chip is not inserted. Other ink errors
	Flashing	Printing is not possible. <ul style="list-style-type: none"> Ink expired (2 months passed)

Media sensor

The media sensor detects the presence/absence of media. The sensor must be covered by the media to detect the media width.

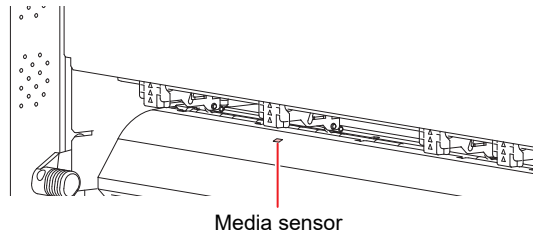

Power supply switch

● Main power supply switch

This is located on the right-hand side of the product.

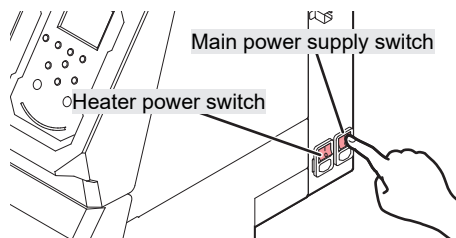

- Do not turn off the main power supply. Turning off the main power supply will disable the automatic maintenance function (including nozzle clogging prevention function and ink discharge channel cleaning function). This will increase the risk of print defects (e.g., nozzle clogging, deflection).

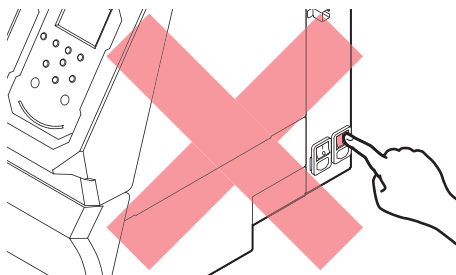

● [END/POWER] key

The [END/POWER] key is the key normally used to turn the power on and off.

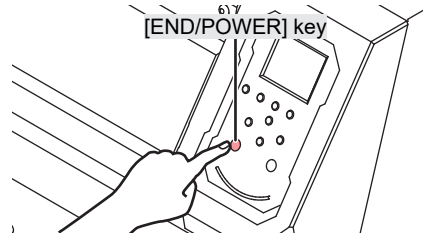

- Close the front cover and maintenance covers. Leaving any of the covers open will disable the automatic maintenance function (including nozzle clogging prevention function and ink discharge channel cleaning function). This will increase the risk of failure or printing defects (e.g., nozzle clogging or deflection).

Operating panel

This is used to control the product and make/change settings.

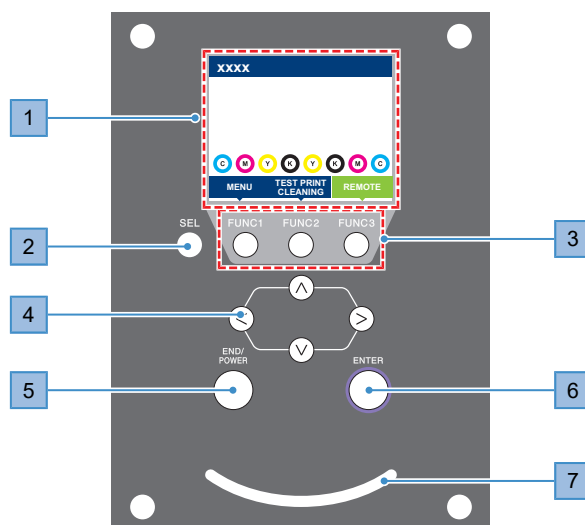

No.	Name	Outline																
1	Display	"Display"(P. 27)																
2	[SEL] key	Selects the function for the corresponding [FUNCTION] key.																
3	[FUNCTION] key	Used for test printing, head cleaning, and editing settings "[FUNCTION] key"(P. 28)																
4	[JOG] key 	Used to move the carriage, feed media, and select settings																
5	[END/POWER] key	Used to cancel the last setting entered, return to the previous level of the setting menu, or to turn power on and off <ul style="list-style-type: none"> • Illuminates in blue when the power is on. "Turning On the Power"(P. 30) • To turn off the power, hold down the key. "Turning Off the Power"(P. 31) 																
6	[ENTER] key	Used to move to the next level menu and to confirm settings. This can also be used to display product information. "Displaying Machine Information (Local Guidance)"(P. 29)																
7	Status lamp	This lamp indicates the product status. <table border="1" data-bbox="454 1406 1436 1924"> <tbody> <tr> <td>Off</td> <td></td> <td>Indicates LOCAL mode. Used for test printing, maintenance, and settings</td> </tr> <tr> <td rowspan="2">Light blue</td> <td>Illuminated</td> <td>Indicates REMOTE mode. The product is in standby to receive print data.</td> </tr> <tr> <td>Flashing</td> <td>Indicates printing is underway. This also flashes to indicate test printing—for example, when printing built-in patterns.</td> </tr> <tr> <td>Blue</td> <td>Illuminated</td> <td>Indicates that data remains to be printed. Switch to REMOTE mode and start printing</td> </tr> <tr> <td rowspan="2">Red</td> <td>Flashing</td> <td>An error has occurred. Refer to the error code list and take appropriate action. "Error messages"(P. 125)</td> </tr> <tr> <td>Illuminated</td> <td>An error (SYSTEM HALT) has occurred. Contact our service office. "SYSTEM HALT"(P. 130)</td> </tr> </tbody> </table>	Off		Indicates LOCAL mode. Used for test printing, maintenance, and settings	Light blue	Illuminated	Indicates REMOTE mode. The product is in standby to receive print data.	Flashing	Indicates printing is underway. This also flashes to indicate test printing—for example, when printing built-in patterns.	Blue	Illuminated	Indicates that data remains to be printed. Switch to REMOTE mode and start printing	Red	Flashing	An error has occurred. Refer to the error code list and take appropriate action. "Error messages"(P. 125)	Illuminated	An error (SYSTEM HALT) has occurred. Contact our service office. "SYSTEM HALT"(P. 130)
Off		Indicates LOCAL mode. Used for test printing, maintenance, and settings																
Light blue	Illuminated	Indicates REMOTE mode. The product is in standby to receive print data.																
	Flashing	Indicates printing is underway. This also flashes to indicate test printing—for example, when printing built-in patterns.																
Blue	Illuminated	Indicates that data remains to be printed. Switch to REMOTE mode and start printing																
Red	Flashing	An error has occurred. Refer to the error code list and take appropriate action. "Error messages"(P. 125)																
	Illuminated	An error (SYSTEM HALT) has occurred. Contact our service office. "SYSTEM HALT"(P. 130)																

Display

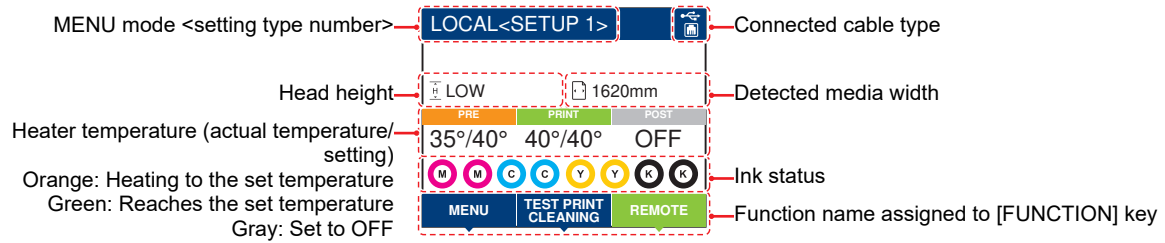

MENU mode

Four menu modes are available.

Name	Outline
LOCAL mode	Used for test printing, maintenance, and settings
REMOTE mode	Prints the print data received from a PC.
MENU mode	Press the [MENU] on the LOCAL mode screen to switch to MENU mode. This is used to set various functions.
NOT-READY mode	Status before media is detected















Ink status

Ink pack status such as remaining ink levels and ink errors are indicated by icons.

Icon	Outline
	Displays remaining ink levels using a 9-stage icon.
	Full
	1/8 used
	1/4 used
	3/8 used
	1/2 used
	5/8 used
	3/4 used
	7/8 used
	Displayed when ink is nearly depleted Very little ink remains. Provide fresh ink. * Indicates ink end for UISS (two ink bottles of the same color are fitted).
	Displayed when ink is depleted or an ink error has occurred Printing is not possible. "Ink error"(P. 124)
	Displayed when the ink has passed its expiration date. Replace with new ink or use up as quickly as possible. Printing is possible. "Restrictions concerning the product"(P. 13)

[FUNCTION] key

This section describes the functions and roles assigned to the [FUNCTION] key.

Icon	Outline
	Displays the various menu screens.  "Settings"(P. 71)
	Displays maintenance functions such as test printing and cleaning.
	Used to switch from LOCAL mode to REMOTE mode.
	Displays adjustment functions such as feed adjustment and drop position adjustment.
	Displays the Heater Temperature Setup screen.
	Clears received data.
	Used to switch from REMOTE mode to LOCAL mode
	Used to cut media
	Used to move to the previous menu screen
	Used to move to the next menu screen
	Used to close the confirmation screen in response to prompts or other messages
	Used to disable functions
	Indicates that the function is assigned. Displays settings and functions.
	Used to enable or disable multiple items

Displaying Machine Information (Local Guidance)

Press the [ENTER] key on the LOCAL mode screen to display the following information.

- Ink information: Displays ink type, remaining ink levels, and ink errors.
- Ink IC chip registration information: Displays the information registered on the ink IC chip.
- Warning: Displays all warnings issued.
- Information: Displays information such as media width, head height, product serial number, firmware version, command version, and LAN connection status.
- Nozzle check: Displays the number of nozzles detected to be clogged in the nozzle check.

1.2 Connecting the Power Cable

- 1 Check to confirm that the main power supply is turned off.
- 2 Insert the cable band to the machine.
- 3 Plug the power cable into the inlet of the machine.
- 4 Secure the power cable to the cable band.
 - Pass the power cable through the clamp and clamp until it clicks into place.

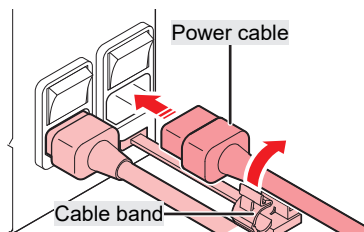

- 5 Plug the power plug into the power outlet.

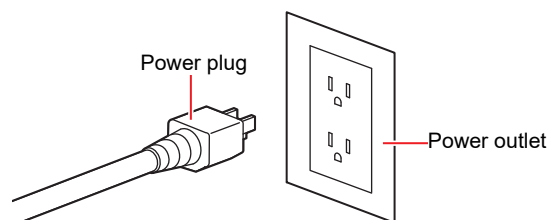

- Do not handle the power plug with wet hands. There is a risk of electric shock.

Turning On the Power



- Close the front cover and maintenance covers. Leaving any of the covers open will disable the automatic maintenance function (including nozzle clogging prevention function and ink discharge channel cleaning function). This will increase the risk of failure or printing defects (e.g., nozzle clogging or deflection).

- 1 Check to confirm that the main power supply is turned on.
 - If the main power supply is not turned on, set the switch to "I".

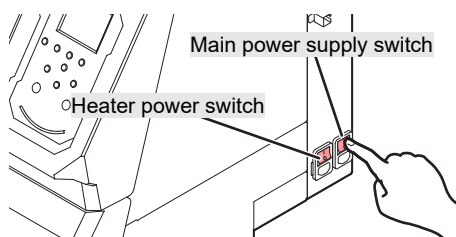

2 Press the [END/POWER] key to turn on power.

- The firmware version appears on the display, and the initial operation is executed. LOCAL mode is then set and the machine is ready for use.

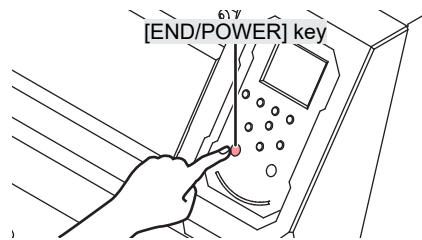

3 Turn on the power for the connected PC.

Turning Off the Power



- Check the following when turning off power:
 - The front cover and maintenance covers are closed.
 - Leaving any of the covers open will disable the automatic maintenance function (including nozzle clogging prevention function and ink discharge channel cleaning function).
 - The carriage has returned to the capping station.
 - If not, the print head nozzle may dry out, resulting in printing defects (e.g., nozzle clogging or deflection).
 - Data is not being received
 - No errors have occurred.
 -  ["Problems indicated by messages"\(P. 122\)](#)

1 Turn off the power to the PC connected.

2 Hold down the [END/POWER] key.

- A power off confirmation screen appears. Press the [ENTER] key to turn the power off.

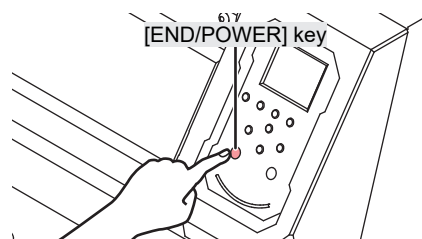

- Do not turn off the main power supply. Turning off the main power supply will disable the automatic maintenance function (including nozzle clogging prevention function and ink discharge channel cleaning function). This will increase the risk of print defects (e.g., nozzle clogging, deflection).

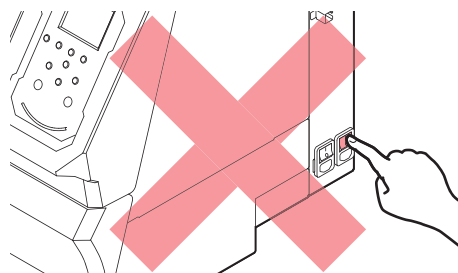

1.3 Connecting a PC to the Product

Using a USB Cable

Connect a PC to this product using a USB interface cable.



- Do not unplug the cable while data is being transferred.



- Use RIP software that supports the USB interface.



- If the PC does not have a USB port, contact your local distributor, our sales office, or service center.

USB Connection Precautions

● When connecting more than one JV100-160 to a PC

The JV100-160 may not be correctly recognized.

If the PC has more than one USB port, try connecting to a different USB port to check whether the product is correctly recognized. If the product is still unrecognized even when connected to a different USB port, use a commercially-available USB active repeater cable.

● When extending the USB cable

Use a commercially-available USB active repeater cable. However, make sure that the combined length of the USB cable and the USB active repeater cable does not exceed 20 m.

Data transfer speeds to this product may be reduced if the USB cable is extended. This may cause the carriage to temporarily stop at the left-hand or right-hand end during printing.

● USB high-speed mode peripheral devices

It may not be possible to recognize USB peripheral devices if USB high-speed mode peripheral devices (e.g., USB memory, USB HDD devices) are connected to the PC to which the product is connected. Data transfer speeds to this product may be reduced if external USB hard disk drives or similar devices are connected. This may cause the carriage to temporarily stop at the left-hand or right-hand end during printing.

● Unplugging USB memory devices

When unplugging USB memory devices from the PC to which this product is connected, use “Stop” in “Safely removing hardware” before unplugging. Otherwise, an [ERROR ** command error] will occur.

Using a LAN Cable

Connect a PC to this product using a LAN cable. Insert a LAN cable until it engages with a click.



- Do not unplug the cable while data is being transferred.

● Network Connection Precautions

Make sure the network is set up as follows: Printing is not possible if the network is not set up correctly.

- Use a Category 6 or higher LAN cable.

- The PC used to transfer print data must be located on the same network as this product. This product cannot be connected via a router.
- Use a 1000BASE-T compatible computer or switching hub. Printing requires 1000BASE-T support.

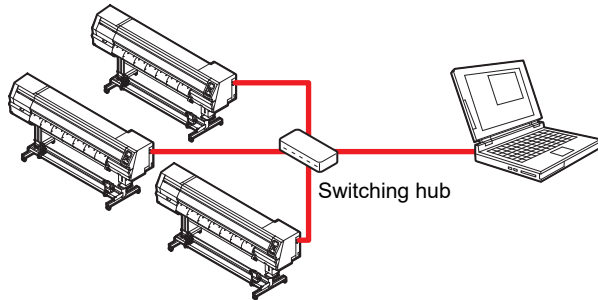

● Checking the LAN connection

1 Check the display on this product.

- Local guidance can be used for checking. ["Displaying Machine Information \(Local Guidance\)"\(P. 29\)](#)
- Printing is not possible if "100Mbps", "10Mbps", or "No Connect" is displayed. Event email can be used. ["Event Email Function Settings"\(P. 84\)](#)

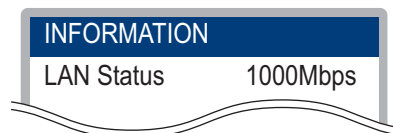

2 Check the lamp on the LAN connector.

- The LAN connector lamp illuminates when this machine is running.

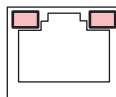

Color	Status	Outline
Green	Illuminated	Connected via 1000BASE-T
	Off	Connected via a network other than 1000BASE-T <ul style="list-style-type: none"> • 1,000 Mbps is not supported if only the orange lamp is illuminated or flashing. Check the specifications for the PC, peripheral devices, and cable.
Orange	Illuminated	Linked up (connected).
	Flashing	Data being received
	Off	Link down (not connected)

1.4 System Configuration

Use RIP software to request to print data created using applications like Illustrator or Photoshop.

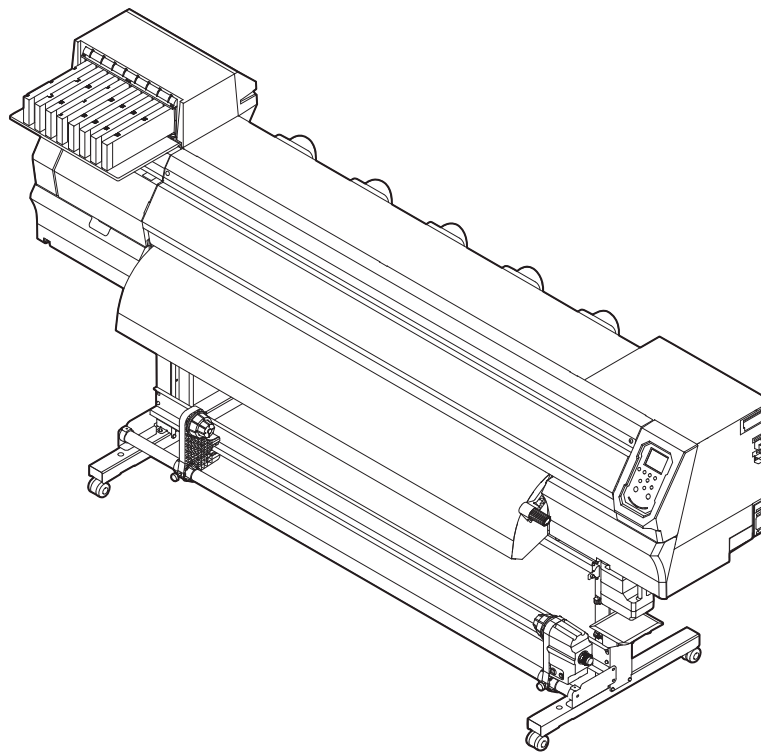
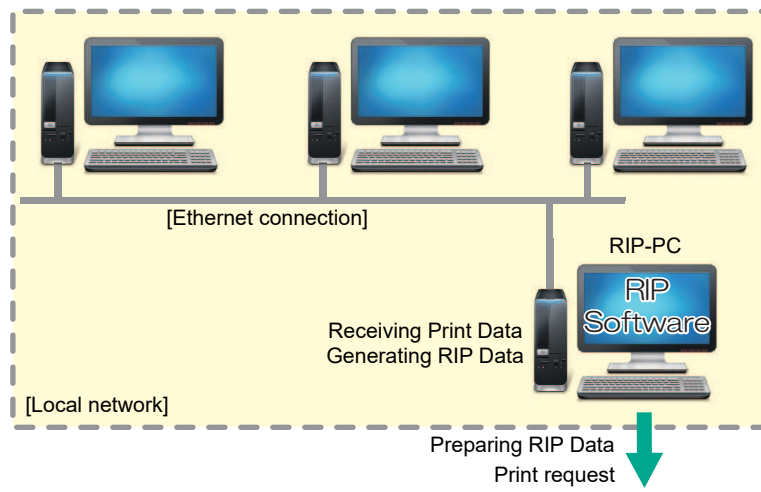

Installing Mimaki Driver

1 Download the Mimaki driver from our website.

- <https://mimaki.com/download/inkjet.html>
[JV100-160] > [Drivers/Utilities]

2 Install the MIMAKI driver.

Installing RIP Software

The explanation here applies to MIMAKI RIP software (RasterLink).

1 Install RasterLink.

- The following icon appears on the PC desktop once the software has been installed.



- For more information, refer to the RasterLink installation guide.
<https://mimaki.com/download/software.html>



- Once installed, activate the license for Rasterlink. Otherwise, “Profile Update” will not start.

Obtaining Color Profiles

Print quality (e.g., tone, bleeding) will vary depending on the media and ink set. To maintain consistent print quality, select a color profile that suits the media and ink set.

The explanation here applies to MIMAKI RIP software (RasterLink).

1 Launch “Profile Update”.

- (1) From the Start menu, select [Mimaki RasterLink7] > [Profile Update].
- (2) Click [Next].

2 Select the JV100-160 being used.

- Select the check box for the ink set and ink type being used, then click [Next].

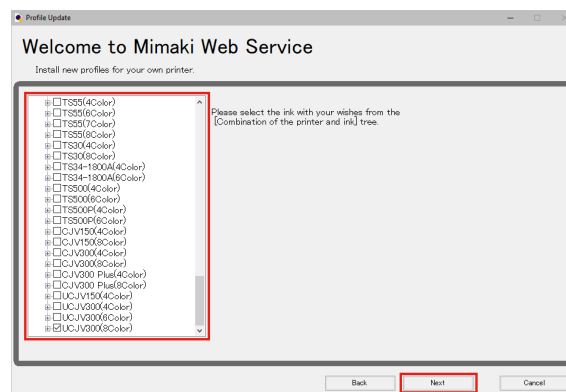

- Expanding the [+] button allows selection of the ink type.

3 Select the required resolution and media material, and then click [Next].

4 Download the color profile.

- (1) Select the check box for the color profile corresponding to the media and resolution to be used.

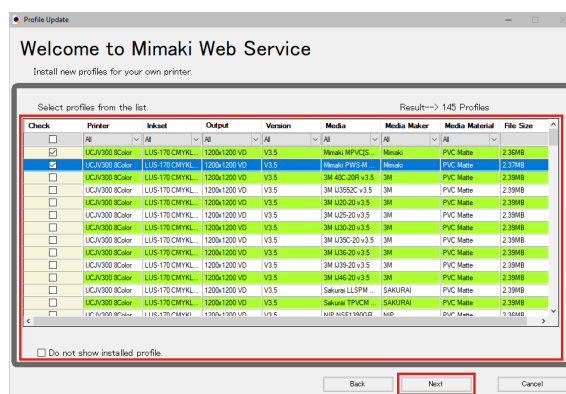

- (2) Click [Next].

- The profile downloaded here will be installed the next time RasterLink is launched.

5 Click [End].

- “Profile Update” closes.



- For more information, refer to the RasterLink installation guide. <https://mimaki.com/download/software.html>



- The latest color profiles can also be downloaded from our website. The profiles downloaded can be installed using Profile Manager. <https://mimaki.com/download/inkjet.html> [JV100-160] > [Profile]

Setting Up RIP Software

The explanation here applies to MIMAKI RIP software (RasterLink).

1 Launch RasterLink.

- The [Printer Management] screen appears.
- To add a new model, launch RasterLink, then select [Environment] > [Printer Management].

2 Register JV100-160.

(1) Click [Add].

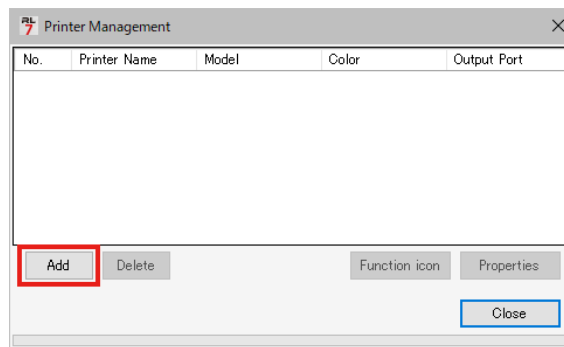

(2) Set the specifics for JV100-160.

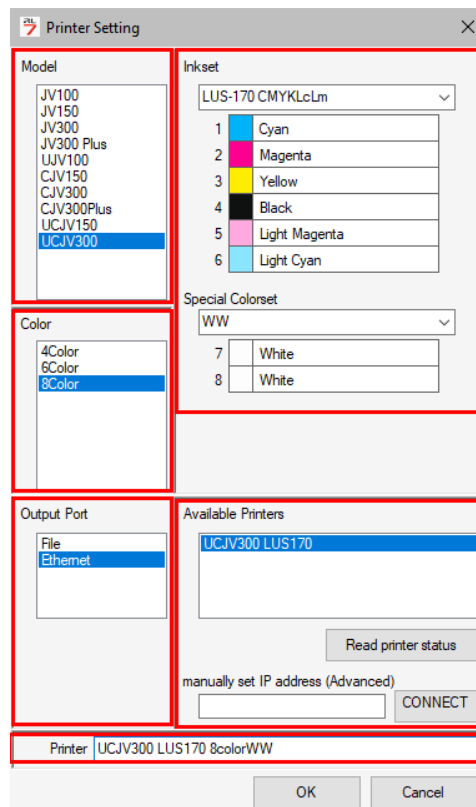

- Model: Select the model.
 - Color: Select the ink set filled.
 - Output port: Select the cable connected.
 - Available Printers: Select JV100-160 connected.
 - Printer name: Enter a name as required.
- (3) Click [OK].
- A confirmation screen appears.
- (4) Click [Yes].
- Printer registration starts.



- For more information, refer to the RasterLink installation guide. <https://mimaki.com/download/software.html>

1.5 Ink Replacement Method

When Ink Level Low or Ink Near End is displayed



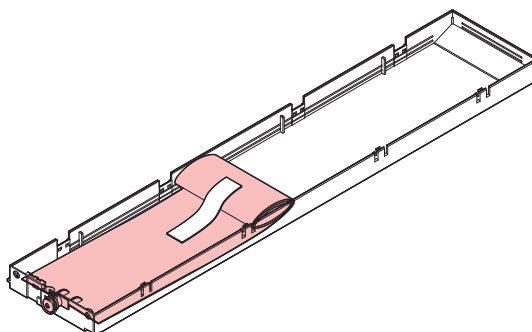

This unit counts the amount of ink consumed. For some reason, there may be an error between the actual ink consumption and the count value. If warning message appears, follow the instructions on the operation panel.

- Important!**
- When the Ink cartridge check appears, be sure to open the cover of the ink cartridge and bend the ink pack. If you continue printing without folding the ink pack, there is a risk that ink will not be ejected.

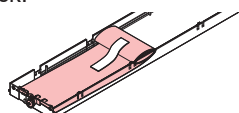

- If you are using a 4-color ink color set, do not continue printing when both of the ink packs of the same color are low.

Message	Display Condition *1	Printer operation		Measures
		Printing	Cleaning	
Ink cartridge check ver.4.2 or later	<ul style="list-style-type: none"> The ink remaining in the 600 ml cartridge is below 250 ml. 	Available	Available	1. Remove the ink cartridge, and measure the weight. "Correcting the Ink Cartridge Case Weight"(P. 83)
Ink level end (1 First time) ver.4.2 or later	<ul style="list-style-type: none"> After the Ink cartridge check was displayed, 130ml of ink was consumed. <ul style="list-style-type: none"> It will not appear if you have performed ink pack folding and cartridge weight correction ("Correcting the Ink Cartridge Case Weight"(P. 83)) after the Ink cartridge check appears. 	Unavailable *3	Unavailable	2. Enter the measured weight into the machine. "Correcting the Ink Cartridge Case Weight"(P. 83) 3. Open the lid on the ink cartridge and fold the ink pack.  Set the ink pack as shown and enter the cartridge weight.
Ink level low	<ul style="list-style-type: none"> The ink remaining in the 600 ml cartridge is below 60 ml. 	Available *2	Unavailable	1. Remove the ink cartridge, and measure the weight. "Correcting the Ink Cartridge Case Weight"(P. 83)
INK NEAR-END	<ul style="list-style-type: none"> The amount of ink remaining after cartridge weight compensation ("Correcting the Ink Cartridge Case Weight"(P. 83)) is below 60ml. 	Available *2	Unavailable	2. Enter the measured weight into the machine. "Correcting the Ink Cartridge Case Weight"(P. 83)

Message	Display Condition *1	Printer operation		Measures
		Printing	Cleaning	
Ink level end	<ul style="list-style-type: none"> The ink remaining in the 600 ml cartridge is below 30ml. 	Unavailable ^{*3}	Unavailable	<ol style="list-style-type: none"> Remove the ink cartridge, and measure the weight.  "Correcting the Ink Cartridge Case Weight"(P. 83) Enter the measured weight into the machine.  "Correcting the Ink Cartridge Case Weight"(P. 83)
Replace Inkpack (Ink End)	<ul style="list-style-type: none"> The amount of ink remaining after cartridge weight compensation ( "Correcting the Ink Cartridge Case Weight"(P. 83)) is below 30ml. 	Unavailable	Unavailable	<ol style="list-style-type: none"> Replace Ink pack.  "Replacing Ink"(P. 40)

*1. The remaining ink values are for reference only.

*2. Repeat Printing is not possible. However, in the case of a four-color ink set, continuous printing is possible as long as there is no warning in the other ink cartridge.

*3. In the case of a four-color ink set, it will switch to the other cartridge.

When Ink End is Displayed

The ink has run out. Replace with new Ink pack.

Thoroughly read the following and make sure you understand its contents.

 ["Ink or any Other Liquid Used with the Machine"](#)(P. 12)



- Pay close attention to ventilation and be sure to wear safety glasses, gloves, and a mask when handling ink, maintenance liquid, waste ink, or other solutions used with this machine. Leaking ink may adhere to the skin or get into the eyes or mouth.



- The ink in the ink pack cannot be used up completely. The ink pack is filled up with the amount of ink which is slightly more than the indicated value. As ink end occurs when the indicated amount of ink is consumed, a small amount of ink remains.

Replacing Ink



- When replacing with a new 600 ml ink cartridge case, register (☞ "Replace with a new ink cartridge"(P. 82)) the case weight.



- When replacing with a new ink pack, cartridge weight input (☞ "Correcting the Ink Cartridge Case Weight"(P. 83)) is not required.

● Removing the Ink cartridge

- 1 Remove the ink cartridge.

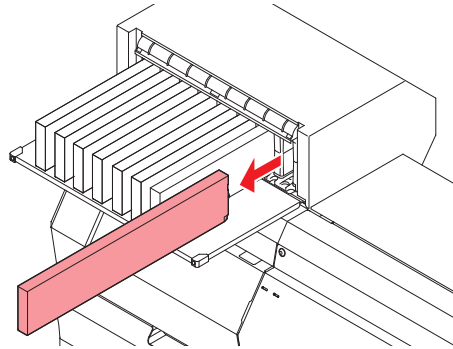

- When disposing of the product, contact an industrial waste disposal operator or dispose of the product in accordance with the local laws and regulations.

● Replacing Ink Pack

- 1 Press the claws of the case with your fingers to open the lid.



- 2 Remove the old ink pack.

- 3 Place a new ink pack inside the 600 ml ink cartridge case.

- Push the ink pack connector into the 600ml ink cartridge case slot with the double-sided tape attached side facing down. Ink may not be supplied if the connector is out of position.



4 Adjust the shape of the ink pack.



5 Remove the seal of the double-sided tape.

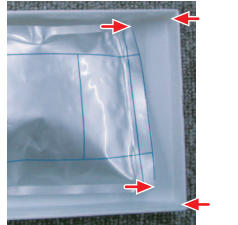
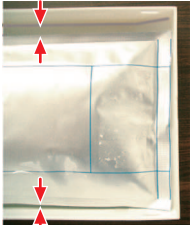

6 Secure the ink pack so that it will not become loose.

Good example	Bad example	
		
The ink pack is aligned with the corner of the case	The corners of the ink pack and the case are not aligned	The ink pack is inclined

7 Close the lid of the case.

- Insert the claws until you hear a click.





- Be careful to avoid catching your hands or fingers.

8 Replace with a new ink IC chip.

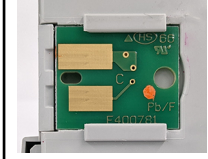
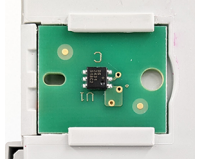
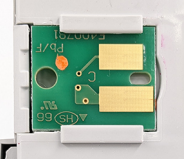
- Slide it to the side to remove it.

Good example	Bad example	
		
	Front and back are reversed	Inserted incorrectly left-to-right

- The marking on the ink IC chip indicates the color information.

Ink color	Marking
Cyan	 (One blue circle)
Magenta	 (One red circle)
Yellow	 (One yellow circle)

Ink color	Marking
Black	● (One black circle)
Light cyan	●● (Two blue circles)
Light magenta	●● (Two red circles)
Light black	●● (Two black circles)
Orange	● (One orange circle)



- Insert the ink IC chip contained in the ink package. The ink IC chip stores information such as the ink color, remaining amount, and expiration date. Printing is not possible if a wrong IC chip is inserted.

9 Shake the Ink cartridge to the left and right slowly at least 20 times.

- Shake the case slowly from left to right to ensure that the ink moves inside.

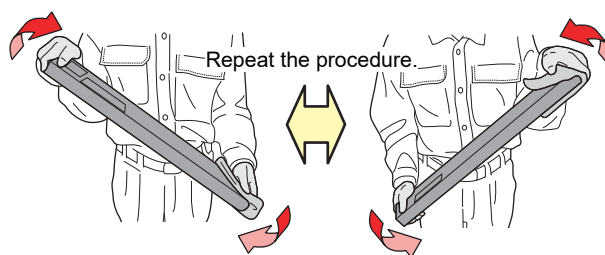

- If the ink cartridge is partially used, flip the ink cartridge upright and shake slowly at an angle, holding the ink cartridge slot with a paper towel.



● Mounting the Ink cartridge

The order of Ink cartridge to be set depends on the ink set you are currently using. Check the ink slot numbers, then insert the correct color Ink cartridge.

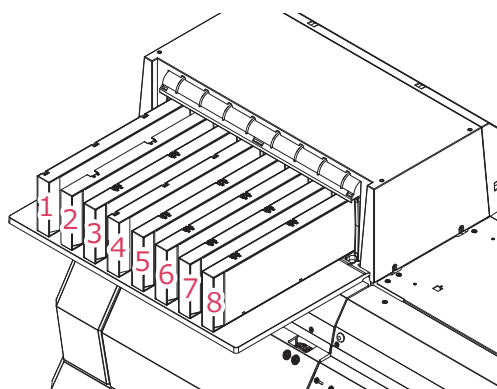

Ink set	Ink layout							
	1	2	3	4	5	6	7	8
4-color (C, M, Y, K)	M	M	C	C	Y	Y	K	K
8-color (C, M, Y, K, Lc, Lm, Lk, Or)	M	Or	C	Lk	Y	Lm	K	Lc

1 Insert the ink cartridge.

- Insert Ink IC chip with it facing left.

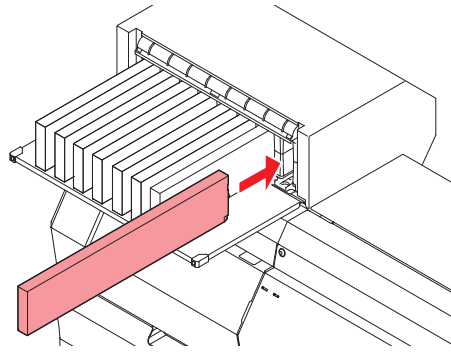

- Fully push in the eco-case. Otherwise, ink may not be fed properly.



- Do not touch the metal parts of the ink IC chip. Static electricity may damage the ink IC chip, and dirt or damage may make the ink IC chip unreadable.

Chapter 2 Printing



This chapter

Describes printing procedures and setting methods.

Print Process	46	Head Cleaning.....	60
Adjusting Print Head Height	49	Feed Correction.....	61
Loading the Media	51	Feed Correction Procedure.....	61
Media	51	Correcting the Drop Position	63
Take-up unit	51	Drop Position Correction Procedure	63
Loading the Roll Media	53	Preparing RIP Data	65
Setting the Heater Temperature	57	Printing RIP Data.....	67
Test Printing	58	Changing the Origin	67
Changing the Layout Direction for Test		Starting Printing	67
Printing	58	Stopping Printing (Data Clear)	68
Printing Defects.....	59	Cutting the Media	69

2.1 Print Process

1. Turn on the power.

 ["Turning On the Power"\(P. 30\)](#)

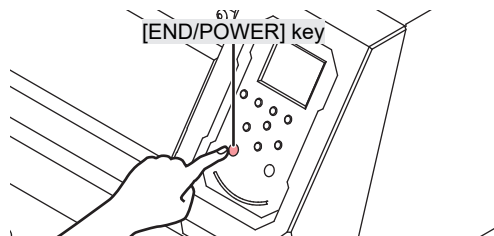

2. Connect a RIP PC to the machine.

 ["Using a USB Cable"\(P. 32\)](#)

 ["Using a LAN Cable"\(P. 32\)](#)

3. Setting Up RIP Software

 ["Installing RIP Software"\(P. 35\)](#) (required first time only)

 ["Obtaining Color Profiles"\(P. 35\)](#)

 ["Setting Up RIP Software"\(P. 36\)](#) (required first time only)

4. Adjust print head height.

Adjust the height adjustment lever to suit the media.  ["Adjusting Print Head Height"\(P. 49\)](#)

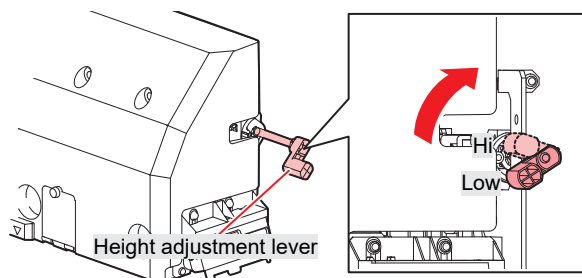

5. Loading the Media

This machine can be used with roll media.  "Loading the Media"(P. 51)

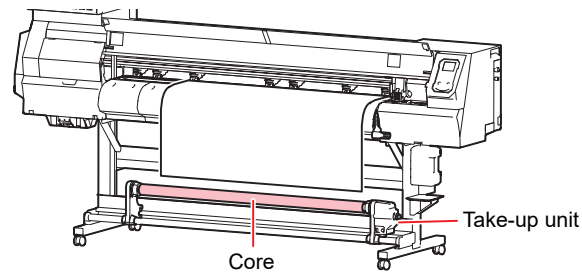

6. Setting the Heater Temperature

 "Setting the Heater Temperature"(P. 57)

7. Check the state of the print head nozzles.

 "Test Printing"(P. 58)

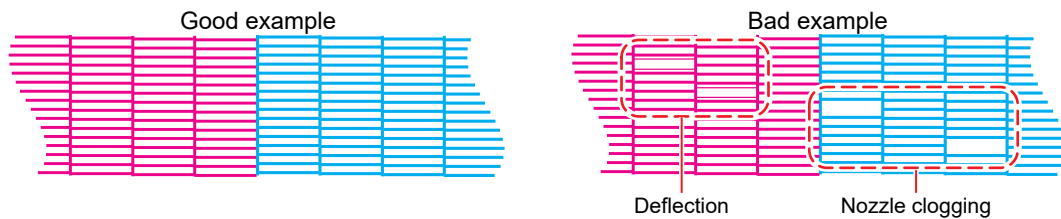

8. Clean the head to clear malfunctioning nozzles.

There are three different head cleaning methods. Choose the head cleaning method based on test print results.  "Head Cleaning"(P. 60)

9. Adjust the media feed amount.

 "Feed Correction"(P. 61)

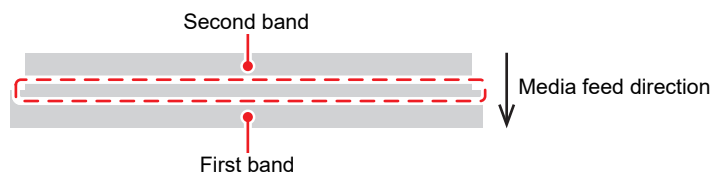

10. Adjust the drop position for bi-directional printing.

☞ "Correcting the Drop Position"(P. 63)

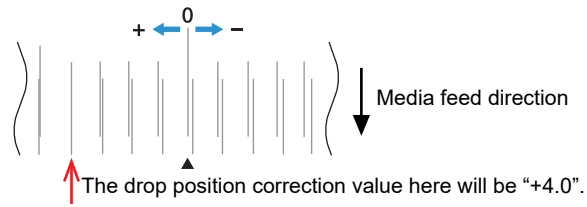

11. Printing RIP Data

☞ "Printing RIP Data"(P. 67)

12. Cutting the Media

☞ "Cutting the Media"(P. 69)

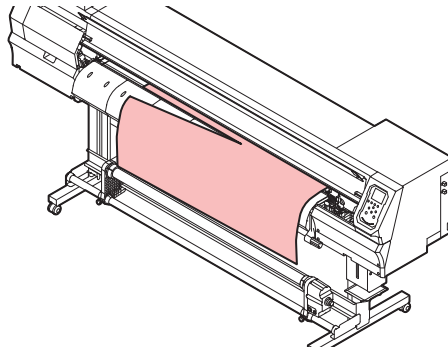

2.2 Adjusting Print Head Height

Adjust the print head height to suit media thickness.

Range	Gap between print head and platen
Low	2 mm (default setting)
High	2.5 mm



- Be sure to correct the dot position after altering the print head height.  "[Correcting the Drop Position](#)"(P. 63)
- Adjust the print head height to suit the media. With inkjet printers, if the gap between the print head and media increases, the ink droplets may vaporize before they reach the media. Vaporized ink may adhere to the print head nozzle surface and media, affecting print quality and causing failure of the print head.

- 1 On the LOCAL mode screen, select [MENU] > [Maintenance], then press the [ENTER] key.**
 - The Maintenance menu is displayed.
- 2 Select [Station] > [Carriage Out] > [Move To Platen Right End], then press the [ENTER] key.**
 - The carriage moves over the platen.
- 3 Open the front cover.**
- 4 Unscrew the carriage cover screws.**
 - Use a flathead screwdriver to unscrew by approximately one turn.

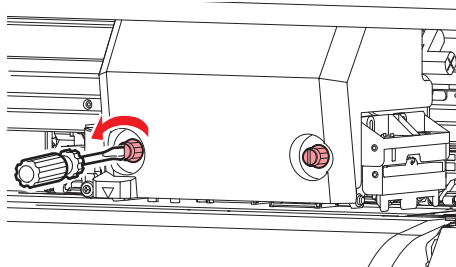

- 5 Use the height adjustment lever to adjust the height.**

- Set the height adjustment lever so that the desired height is at the top. If the lever is not set to the correct position, problems such as media jamming and misting may occur, resulting in impaired print quality.

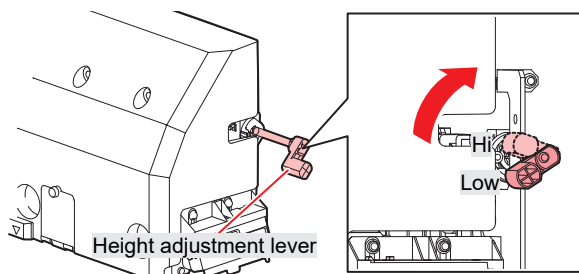

6 Retighten the carriage cover screws.

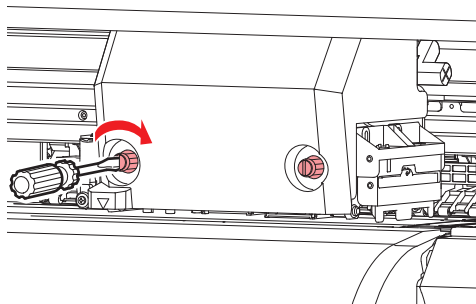

• Do not touch the height adjustment lever.

7 Once adjustment is complete, close the cover, then press the [ENTER] key.

2.3 Loading the Media



- Adjust the head height before loading media. Moving the carriage after the media has been loaded may result in the print head coming into contact with the media and being damaged.

Media

● Media handling precautions



- Use Mimaki-approved media to ensure consistent high-quality printing.

⚠ WARNING



- Assign at least two people to load roll media. Otherwise there is a risk of back injury due to the weight of the media.

NOTICE



- Protect media from dust when stored. Otherwise print quality may be reduced.
- When storing standard-size media rolled up, store with the coated surface facing out.



- Do not leave media loaded in the machine. This may cause dust to collect on media. Also, do not use media after wiping off dust. The static electricity generated by wiping may impair print quality.
- Do not use media immediately after removing from the packaging. The media may expand or shrink depending on the ambient temperature and humidity at the storage location. Allow to sit for at least 30 minutes in the same room conditions as this machine before loading.
- Do not use curled media. Doing so may result in damage to the print head and impaired print quality.



- Printing may show through from the underside depending on the media type and media storage method after printing (such as the load due to placing flat media that have been rolled up). Perform a test beforehand to check that print does not show through from the underside.

Take-up unit

Use the switch on the take-up unit to change the media take-up direction.

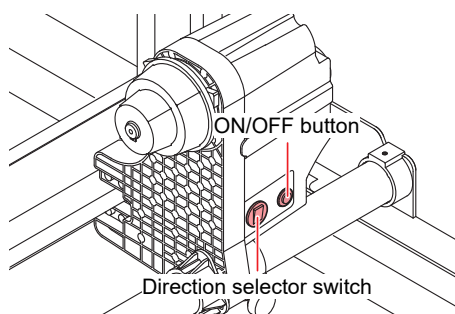

Name	Outline	
Direction selector switch	Up	To take up media with printed surface on the inside
	Down	To take up media with printed surface on the outside

Name	Outline
ON/OFF button	Press the button to start/stop the take-up unit. The setting can be altered so that the take-up unit operates only while the button is depressed. 🗨️ "Machine setup menu" (P. 79)

Adjusting the Torque Limiter

The take-up unit is fitted with a torque limiter. Turn the torque limiter adjustment nut to adjust take-up tension. The torque limiter is initially set to "Medium" when shipped.

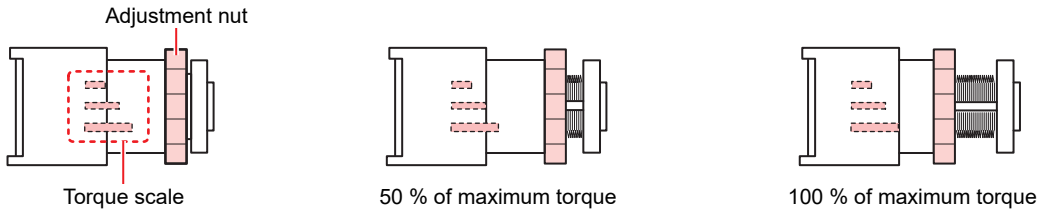

● Increase tension (clockwise)

Increase tension when using with heavy or thick media, such as tarpaulin. Perform adjustments manually.

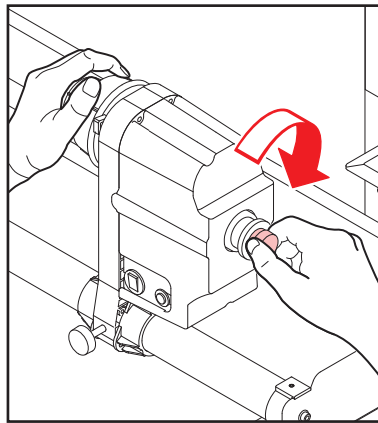

- Do not use the torque adjustment handle. Overtightening with the torque adjustment handle may damage the take-up unit.

● Decrease tension (counterclockwise).

Decrease tension when using lightweight media. Use the "torque adjustment handle" provided.

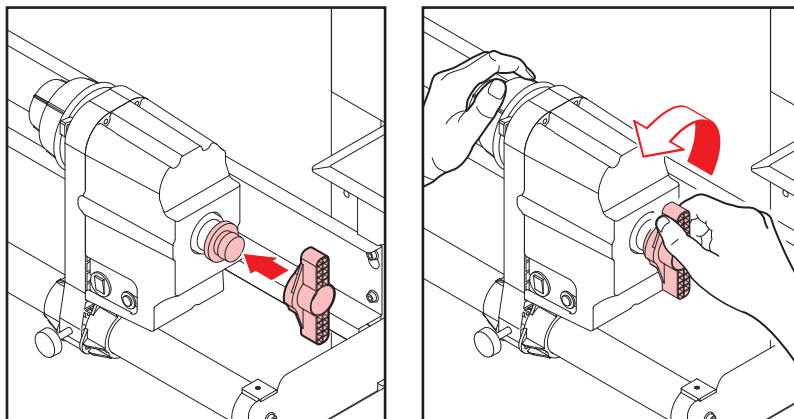

Loading the Roll Media

- 1 Raise the clamp lever.

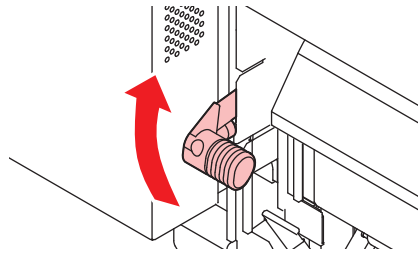

- 2 Move the rear left roll holder to the roll setting position.
 - Unscrew the roll holder retaining screw before moving.

Set the roll holder reference line within the area indicated by the arrows as shown below.

Roll Holder	3 Inch Roll Media	▶	◀
Set Position	2 Inch Roll Media	▶	◀

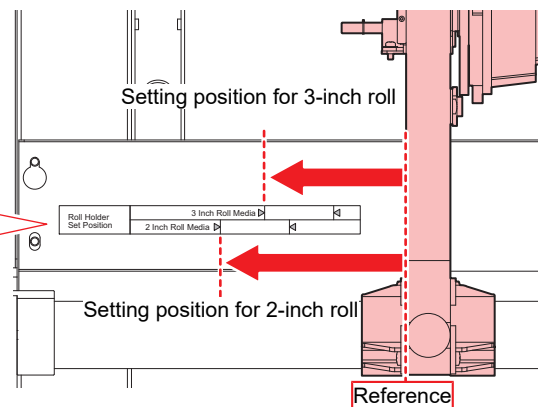

- 3 Tighten the retaining screw on the rear left roll holder.
- 4 Place roll media on the roll media hanger.
- 5 Insert the core of the roll media on to the rear left roll holder.
 - Push in until the core moves no farther.

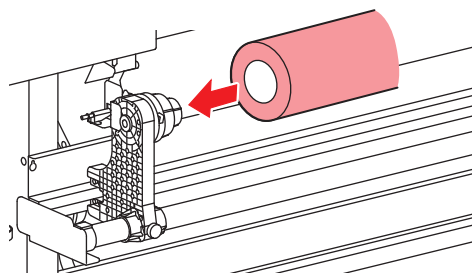

- 6 Insert the rear right roll holder into the core.
 - Unscrew the roll holder retaining screw before moving.

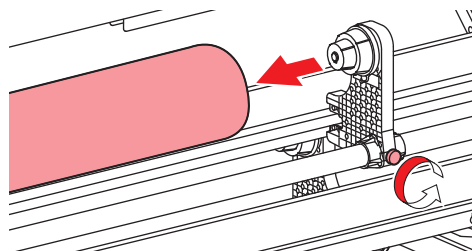

7 Tighten the retaining screw on the rear right roll holder.

8 Insert the media.

- Insert into the gap between the pinch rollers and the grid rollers.



- Inserting the media at an angle allows smooth insertion without catching or sticking.

9 Lower the clamp lever.

- Hold the media with the pinch rollers and grit rollers.

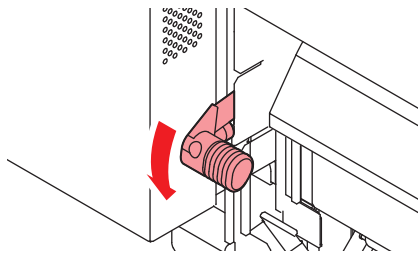

10 Move to the front of the machine and open the front cover.

11 Raise the clamp lever and pull out the media.

- Make sure the media does not fall to the rear.



- Adjust the rear roll holder position so that the media does not cover the right-hand slit line on the platen. Movement at an angle may result in damage to the print head.

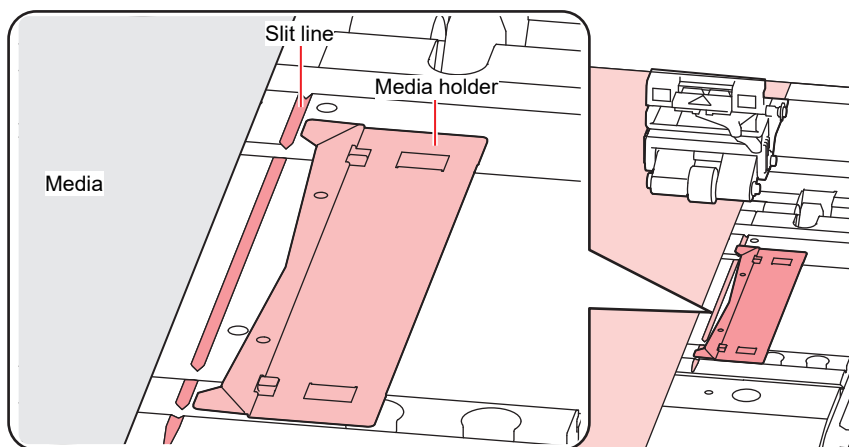

- The areas extending 5 mm from both sides of the media are margins.

12 Gently pull out the media and stop at the position where it is gently locked in place.

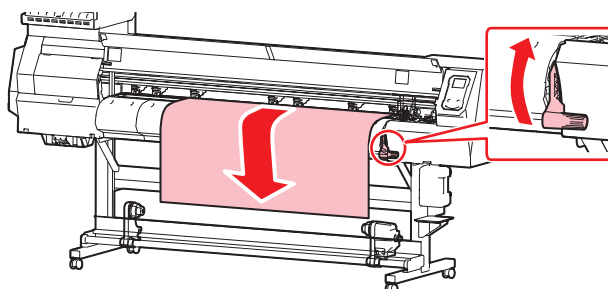

13 Check how far the media was pulled out.

- Pull the front edge of the media gently at several points to confirm that the media was pulled out by the same amount.

14 Lower the clamp lever.

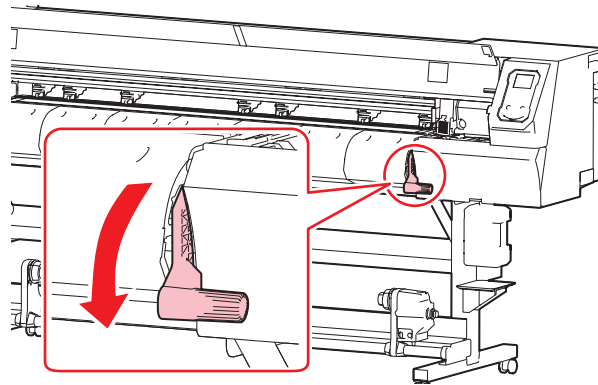

15 Secure the media in the media holder.

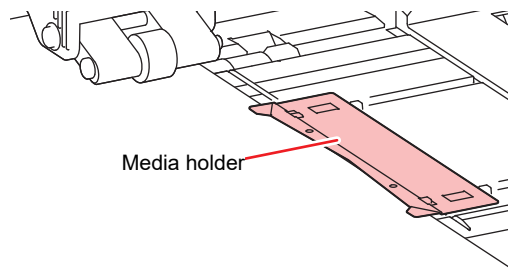

- Do not use the media holder when printing on thicker media.

16 Press , then select "Roll".

- This starts media width detection.
- If the setting for [Machine Setup] > [Media Detect] > [Detection Type] is "MANUAL", the area for printing must be determined manually.
- If the setting for [Machine Setup] > [Media Detect] > [Media Remain] is "ON", the media length input screen will be displayed.



- A notification reading "Media Set Position R" will appear after media width detection if the media is too far to the right of the specified position. Reload media in the specified position.

17 Load an empty core on the take-up unit.

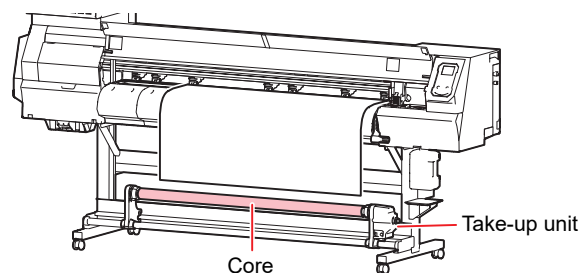

18 Secure the media to the take-up unit.

- (1) Press  to feed the media until it reaches the core on the take-up unit.
- (2) Secure the middle of the media with adhesive tape.
- (3) Secure the media on the right and left in the same way.
 - Pull the lower edge of the media evenly on both the left and right sides, check to confirm that it is free of sagging and creasing, then affix the tape.

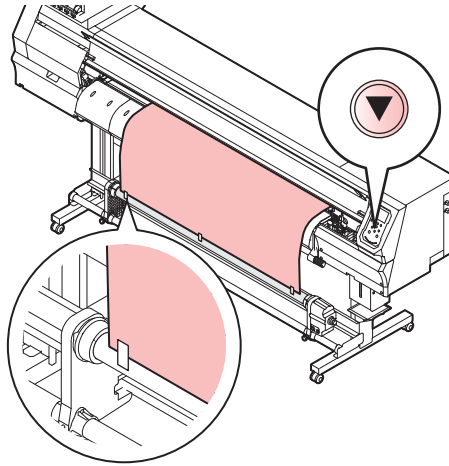

- Move the take-up unit to the left or right when it is not in use. Print quality may be affected if the front edge of the media hits the take-up unit.

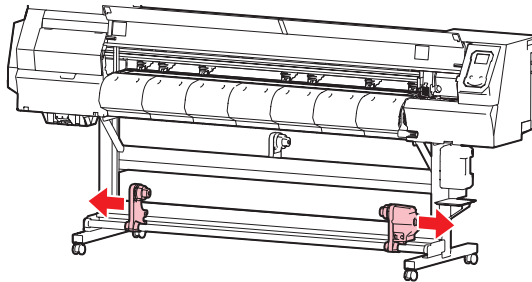

2.4 Setting the Heater Temperature

Adjust the temperature setting to suit the type of media used. The temperature can be altered while printing is in progress, but this may cause color variations to occur.



- The temperature setting in the RIP software takes precedence. If you are using the Mimaki RIP software (RasterLink), the recommended values are stored in the color profile.



- Adjust the heater temperature to suit the media type and characteristics. Depending on the type, the media may expand or shrink or become rippled.

1 On the LOCAL mode screen, select [HEATER].

- The Heater Temperature Setup screen appears.

2 Enter the heater temperatures, then press the [ENTER] key.

- Printing is possible once the heater temperatures reach the temperature settings ± 3 °C.

Name	Outline
PRE (Pre-heater)	Preheats the media before printing to suppress rapid temperature change.
PRINT (Print heater)	Helps prevent ink bleeding.
POST (Post-heater)	Allows ink to dry after printing.

2.5 Test Printing

Print a test pattern to confirm that the ink prints correctly. Perform head cleaning if you observe any print defects (e.g., nozzle clogging, deflection). ["Head Cleaning"\(P. 60\)](#)

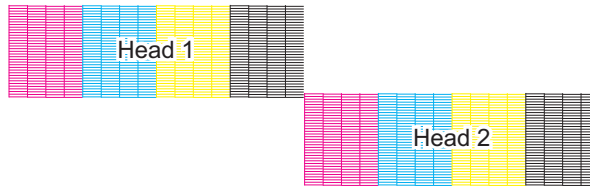

Check beforehand
<ul style="list-style-type: none"> • Was the print head adjusted? "Adjusting Print Head Height"(P. 49) • Is media loaded? "Loading the Media"(P. 51)



- Load media at least 500 mm wide. You cannot print the entire pattern if media less than 500 mm wide is used.



- Select [Maintenance] > [Nozzle Recovery] > [Test Print], then select "ON" to perform nozzle recovery and test printing. Registration is required to perform nozzle recovery. ["Registering nozzle recovery"\(P. 76\)](#)

Changing the Layout Direction for Test Printing

You can change the layout direction for test printing.

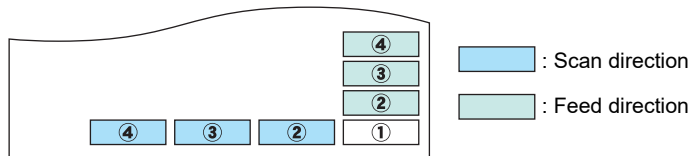

Scan direction	Prints repeatedly in the horizontal direction.
Feed direction	Feeds the medium and prints repeatedly in the longitudinal direction.

1 On the LOCAL mode screen, select [TEST PRINT/CLEANING] > [Test Print], then press the [ENTER] key.

- The Test Print menu is displayed.

2 Select "Scan direction" or "Feed direction", then press the [ENTER] key.

- Test printing starts.

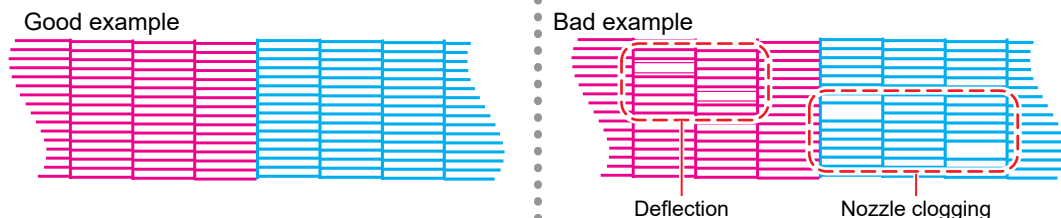

3 Check the print results.

2.6 Head Cleaning

The following head cleaning methods are available. Choose the method based on test results.

Item	Details
Soft	If the print shows a bent line (deflection)
Normal	If the print shows a missing line (nozzle clogging)
Hard	If soft cleaning and normal cleaning fail to resolve print defects (e.g., nozzle clogging, deflection)



- Cleaning is not possible when [Ink Level Low], [Ink Near End], [Ink Level End], or [Ink End] is displayed. The amount of ink required for cleaning may be remaining, so correct the weight of the 600 ml ink cartridge. ["Correcting the Ink Cartridge Case Weight"\(P. 83\)](#)
If a warning is displayed even after correcting the weight, replace with a new ink pack. ["Replacing Ink"\(P. 40\)](#)

- 1 On the LOCAL mode screen, select [TEST PRINT/CLEANING] > [Cleaning], then press the [ENTER] key.**
 - The Cleaning menu is displayed.
- 2 Select the cleaning type, then press the [ENTER] key.**
- 3 Select the Head to clean and press the [ENTER] key.**
 - Check the check box. Heads with checked check boxes will be cleaned.
- 4 Run another test print and check the print results.**
 - Repeat the cleaning and test printing process until the print results appear normal.



- Do the following if head cleaning fails to resolve the print defects (e.g., nozzle clogging, deflection).
["Wiper Cleaning"\(P. 92\)](#)
["Cap Rubber Cleaning"\(P. 93\)](#)
["Print Head Nozzle Washing"\(P. 120\)](#)
 Fill the ink. ([MENU] > [Maintenance] > [FILL UP INK])

2.7 Feed Correction

Changing the media may affect the feed amount due to various factors, including the weight and thickness of the media and whether the take-up unit is used. Correct the drop position to suit the type of media used. Image defects (e.g., dark or light streaks) will result if the feed is not properly corrected.

Check beforehand

- Is media loaded? 🖱️ "Loading the Media"(P. 51)
- For roll media, is the rear roll media free of sagging?
- When using the take-up unit, was the media mounted on the core of the take-up unit? 🖱️ "Loading the Roll Media"(P. 53)

Feed Correction Procedure

Print a correction pattern, then enter the correction value. The value corrected here will also be updated on the settings menu.



- When using the take-up unit, load media on the take-up unit before correcting.

- 1 On the LOCAL mode screen, select [ADJUST].

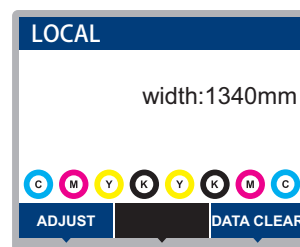

- 2 Select [Feed Comp.], then press the [ENTER] key.

- Correction pattern printing starts.

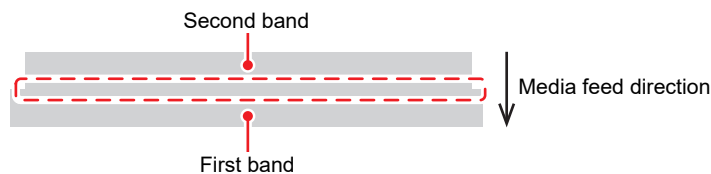

- 3 Check the print results.

- A correction value input screen appears.
- Adjust the bands so that the region between them is evenly colored.

- 4 Enter the correction value, then press the [ENTER] key.

- Enter "+" to increase the separation between bands.
- Enter "-" to reduce the separation between bands.
- Increment the correction value by "30" to move the bands by approximately 0.1 mm.

- 5 Press the [ENTER] key.

- Print another correction pattern to check.



- Once adjustment is complete, the medium will be fed to the print origin. Sagging may occur in the rear roll medium. Rewind roll media by hand to eliminate any sagging.
-

Correcting the Media Feed During Printing



You can also correct the media feed amount in REMOTE mode or while printing.

- 1** Press [ADJUST] in REMOTE mode or while printing.
- 2** Enter the correction value, then press the [ENTER] key.
 - Correction value: -9999 to 9999
 - The value entered here will be updated immediately.

2.8 Correcting the Drop Position

Changing the media and print head height will also alter the drop positions. Correct the drop position to suit the type of media used. Image defects (e.g., overlaid lines or blurred images) will result if the drop position is not properly corrected.

Check beforehand

- Was the print head adjusted?  ["Adjusting Print Head Height"\(P. 49\)](#)
- Is media loaded?  ["Loading the Media"\(P. 51\)](#)



- Load media at least 500 mm wide. You cannot print the entire pattern if media less than 500 mm wide is used.

Drop Position Correction Procedure

Print a correction pattern, then enter the correction value. The value corrected here will also be updated on the settings menu.

- 1 On the LOCAL mode screen, select [ADJUST].

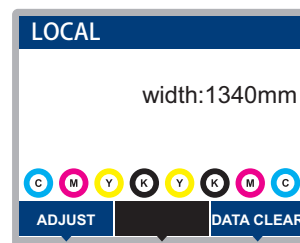

- 2 Select [Drop.PosCorrect], then press the [ENTER] key.

- 3 Select the resolution and press the [ENTER] key.

- Select the resolution to be adjusted. When "All" is selected, correction patterns for all resolutions will be printed.  ["Setup Menu"\(P. 72\)](#)



- The indicated resolutions are those in the scan direction.

- 4 Check the print results.

- A correction value input screen appears.
- Enter the position where the two upper and lower lines coincide.

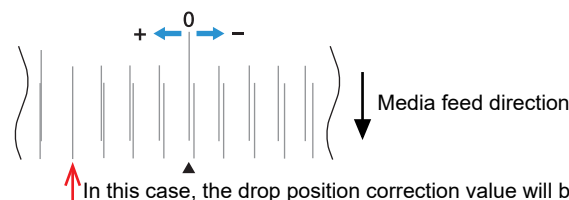

- 5 Enter the correction value, then press the [ENTER] key.

- Correction value: -40 to 40



- If the lines do not coincide when the correction value is within the range -40 to 40, the print head height may have been improperly adjusted. Adjust the print head height.
 ["Adjusting Print Head Height"\(P. 49\)](#)
-

6 Enter the correction value in the same way for pattern 2 and subsequent patterns.

2.9 Preparing RIP Data

The explanation here applies to MIMAKI RIP software (RasterLink).



- Prepare suitable image data for printing.

1 Launch RasterLink.

- Click the icon on the PC desktop.



2 Select the image data to print.

- (1) Select [File] > [Open].
- (2) Select the desired image data, then click [Open].
 - If multiple printers are registered, select JV100-160 in “Printer name”.

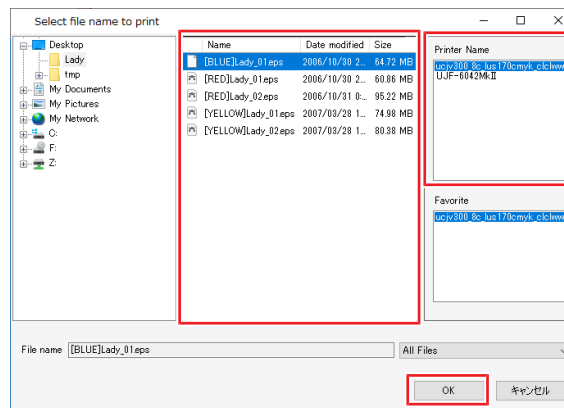

3 Select the image data imported.

- The image is displayed in the tab for JV100-160 selected in “Printer name”.

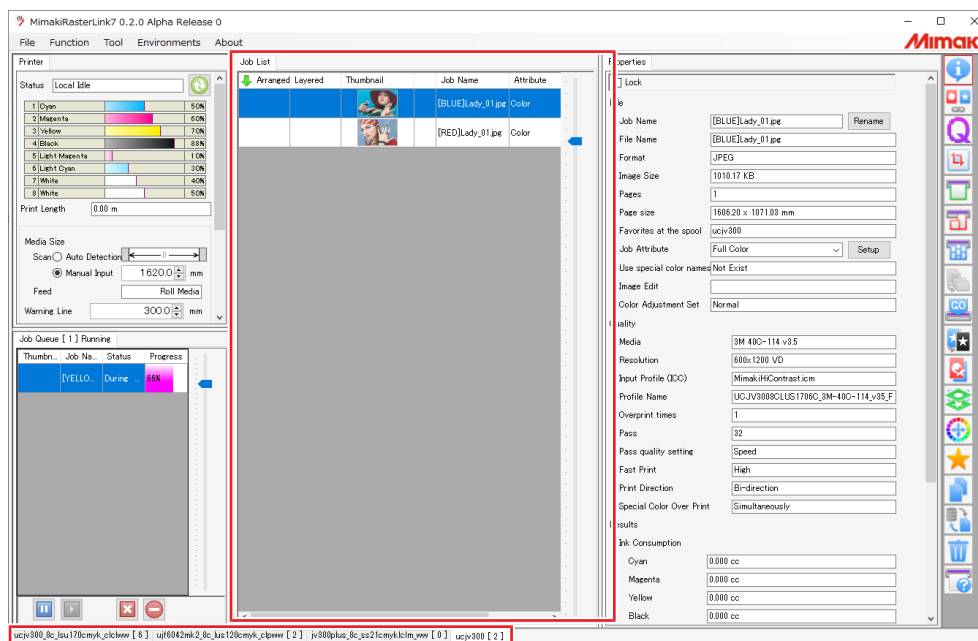

4 Check the settings and alter as necessary.

- Specify the following settings by clicking the function icons shown on the right-hand side of the screen:

 (normal printing): Specifies settings like enlargement/reduction and number of copies.

 (print conditions): Selects a color profile for the media and ink set loaded in this machine.



- For more information, refer to the RasterLink reference guide. <https://mimaki.com/download/software.html>
-

5 Print image data.



- Click  (execute) from the function icons on the right-hand side of the screen. Select “Immediate Print” or “RIP and Print”, then click [Start].
-





- Media width must be reacquired after replacing media.
 - (1) Select the tab for JV100-160 in the main window.
 - (2) Click  (display latest printer status) in the Printer tab.
-

2.10 Printing RIP Data

Check beforehand

- Was the print head adjusted?  ["Adjusting Print Head Height"\(P. 49\)](#)
- Is media loaded?  ["Loading the Media"\(P. 51\)](#)
- For roll media, is the rear roll media free of sagging?
- When using the take-up unit, was the media mounted on the core of the take-up unit?  ["Loading the Roll Media"\(P. 53\)](#)









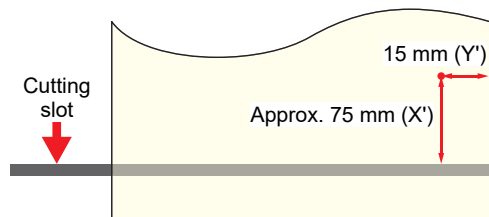

- Condensation may form on the print head nozzle surface depending on the ambient temperature and humidity. The formation of condensation may cause printing defects (e.g., nozzle clogging or deflection). Perform head cleaning if any printing defects (e.g., nozzle clogging or deflection) occur during printing.  ["Head Cleaning"\(P. 60\)](#)
Set the platen heater to a temperature not exceeding 35 °C, and ensure that the ambient temperature is within the permissible operating temperature range (20 °C to 30 °C).  ["Installation Precautions"\(P. 14\)](#)

Changing the Origin

The print start position can be altered. Use the LED pointer to set the origin.

- Print origin default value
 - Feed (longitudinal, X') direction: Approx. 75 mm to rear from platen cutting slot
 - Scan (lateral, Y') direction: 15 mm from right edge of media



- 1 On the LOCAL mode screen, press    .**
 - The Origin Setup screen appears.
- 2 Press     to move the origin to the desired position.**
 - The carriage moves left and right and feeds the medium.
- 3 Press the [ENTER] key.**
 - The origin is updated.

Starting Printing

- 1 Send the RIP data from the PC.**
 -  ["Preparing RIP Data"\(P. 65\)](#)



- When the message "Attention20A Driver Version" appears, install the latest Mimaki driver available from: <https://mimaki.com/download/inkjet.html>

2 Start printing.

- Printing starts once RIP data is received.

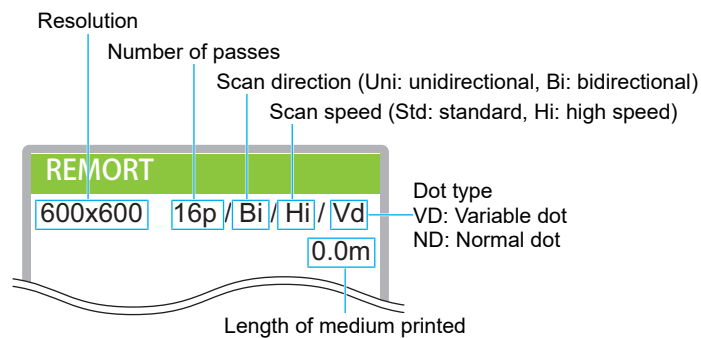

- Print speeds may differ for the same image data, depending on the width of the medium loaded, print origin position, and resolution.
- If an error occurs, the machine switches to LOCAL mode once printing is completed. Further printing is not possible.

Pausing Printing

1 Press [LOCAL] while printing is in progress.

- Printing is paused.
- If data is being sent from a PC, data transmission is paused at the PC.

2 Press [REMOTE].

- Printing resumes.



- No other functions can be used when printing is paused.

Stopping Printing (Data Clear)

1 On the LOCAL mode screen, select [DATA CLEAR].

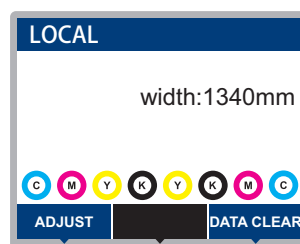

2 Press the [ENTER] key to clear the received data.

- The receive buffer is cleared.

2.11 Cutting the Media

- 1** On the LOCAL mode screen, press ▲▼◀▶.
 - The Origin Setup screen appears.
- 2** Press ▲▼ to feed the media to the position required for cutting.
- 3** Select [CUT], then press the [ENTER] key.
 - The media is cut.

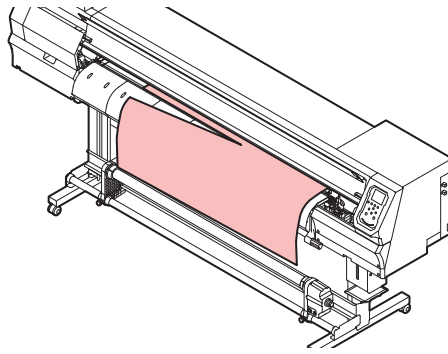

Chapter 3 Settings



This chapter

This chapter describes the methods for replacing maintenance parts.

Setup Menu	72	Machine setup menu	79
Changing the name of a setting type	74	Registering and Correcting a 600 ml Ink Cartridge	82
Maintenance menu	75	Event Email Function Settings	84
Registering nozzle recovery	76	Nozzle check menu	86
		Information menu	87

3.1 Setup Menu

Print conditions (settings 1 to 4) can be saved in advance for specific media.

● Menu List

The user can select to prioritize the settings on the machine or the settings on the PC. Setting individual menus to “HOST” prioritizes PC settings. To prioritize settings for this machine, select a setting other than “HOST”.



- For more information on how to specify RIP software, refer to the RIP software operating manual.

Item	Setting		Details
	*1	*2	
Feed Comp.	-9999 to <u>0</u> to 9999	-	Corrects the media feed amount. <ul style="list-style-type: none"> • Print a pattern and enter the correction amount.
Drop.PosCorrect	-	-	Corrects the drop position for bi-directional printing.
(Resolution)	All/720std/720hi/1200std/1200hi	-	Select the resolution to be corrected. When “All” is selected, correction patterns for all resolutions will be printed.
(Correction value)	-40.0 to <u>0</u> to 40.0	-	Check the pattern and enter correction values.
Auto Correct	-	-	Detects a correction pattern with the sensor and automatically corrects the drop position (automatic correction function). <ul style="list-style-type: none"> • Check to confirm that the media does not lift up. • Load white and clean media. • Synthetic paper or cloth media may not be detected. • Do not send the RIP data from the PC during pattern printing. • If automatic correction is unsuccessful, correct the position manually. [MENU] > [Setup] > [Feed Comp.] or [Drop.PosCorrect]
Feed Comp.	-	-	
Drop.PosCorrect	-	-	
(Resolution)	All/720std/720hi/1200std/1200hi	-	Select the resolution to be corrected. When “All” is selected, correction patterns for all resolutions will be printed.
(Correction value)	-40.0 to <u>0</u> to 40.0	-	Check the pattern and enter correction values.
Heater	-	-	Set the heater temperature.
PRE	OFF/20 to 60 °C	OFF	Preheats the media before printing to suppress rapid temperature change.
PRINT	OFF/20 to 50 °C		Helps prevent ink bleeding.
POST	OFF/20 to 60 °C		Allows ink to dry after printing.
OFF TIME	None / 0 to 90 min	-	Sets the time before turning the heater off after printing.
Logical Seek	HOST/ON/OFF	OFF	Sets the range of carriage movement.

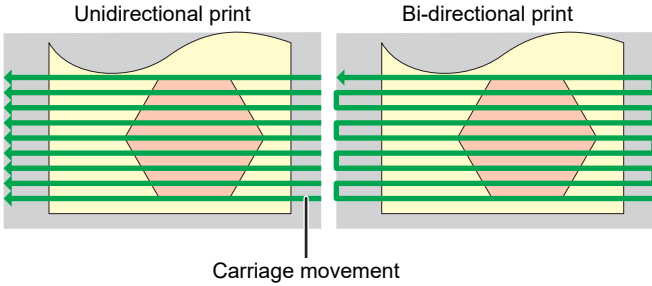
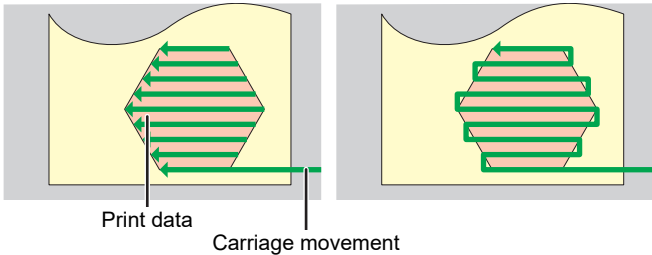
Item	Setting		Details
	*1	*2	
			<ul style="list-style-type: none"> OFF: Machine size area  ON: Print data area 
DRYING TIME	-	-	Sets the ink drying time.
Scan	<u>HOST</u> /0.0 to 9.9 sec	0	Sets the time to stop the carriage each time the carriage scans. <ul style="list-style-type: none"> In the MIMAKI RIP software (RasterLink), it is indicated as the “drying time after each scan”.
PRINT END	<u>HOST</u> /0 to 120 min	0	Sets the stop time after printing. After the set time passes, the next data is printed. <ul style="list-style-type: none"> The Mimaki RIP software (RasterLink) does not allow the user to specify PRINT END. If the machine is set to “HOST”, the time will be “0”.
Margin/Left	<u>HOST</u> /-10 to 85 mm	0m m	Sets the offset value from the media left and right standard margins (15 mm). <ul style="list-style-type: none"> The left and right margins should be set to at least -5 mm when using the media holder. This eliminates the risk of printing on top of the media holder. The Mimaki RIP software (RasterLink) does not allow the user to specify margins. If the machine is set to “HOST”, the offset value will be “0 mm” for the left and right margins.
Margin/Right			
Vacuum fan	<u>HOST</u> /Weak/ Standard/ Strong	Strong	Sets the force with which the medium is held down. <ul style="list-style-type: none"> This can be used to prevent media jamming and print head damage caused by the media lifting up.
Feed Speed	<u>HOST</u> /10 to 100 to 200 %	100	Sets the media feed speed. <ul style="list-style-type: none"> Depending on print conditions, the speed may not vary for certain settings. Setting to 100 % or more reduces the time required to complete printing but may affect print quality due to insufficient drying time.
Auto Cleaning	-	-	Sets the conditions to perform auto head cleaning after the preset number of files are printed.

Item	Setting		Details
	*1	*2	
SETUP	<u>File/Length/</u> <u>Time/OFF</u>	-	Sets the conditions to perform auto head cleaning.
Interval	-	-	Sets auto head cleaning intervals.
(File)	1 to 1,000	-	Sets the interval at which the number of files is selected.
(Length)	0.1 m to 100.0 m	-	Sets the interval at which the print length is selected.
(Time)	10 to <u>60</u> to 240 min	-	Sets the interval at which the print time is selected.
Type	Normal/Soft/ Hard	-	Sets the head cleaning type.
Cleaning Check	ON/OFF	-	Sets whether nozzle checking is performed after auto head cleaning is completed.
External heater	ON/OFF	-	Set when the external heater is used. For more information, refer to the operation manual for the small relay box.
MAPS4	-	-	MAPS: Mimaki Advanced Pass System <ul style="list-style-type: none"> This function disperses the boundaries between passes to make feed streaks between passes less visible. Altering MAPS may alter the color. This function may be less effective with certain types of images.
MAPS4	<u>AUTO/</u> <u>MANUAL</u>	-	This should normally be set to "AUTO". When set to "MANUAL", the following items are displayed:
Smoothing Level	0 to 100 %	-	Increasing smoothing makes streaks less visible.
Speed	50 to 100 %	-	Reducing speed will make streaks less visible. However, printing will be slower.
Expansion	ON/OFF	-	Selecting "ON" will make streaks less visible. However, it may increase visible grain.
Setup Reset	-	-	Initializes the details set.

*1. The default settings are shown underlined.

*2. Settings applied if no settings can be made in the RIP software (host) or if this machine is prioritized.

Changing the name of a setting type















You can change the name of a setting type. The name can include alphanumeric characters or symbols.

- 1** On the LOCAL mode screen, select [MENU] > [Setup], then press the [ENTER] key.
 - The setting types are displayed.
- 2** Select Settings 1 to 4 and press the [FUNC2] key.
 - The rename screen appears.
- 3** Enter the desired name, then press the [ENTER] key.
 - The setting type is renamed.

3.2 Maintenance menu

This menu is used for maintenance actions. It also lets the user perform nozzle recovery if nozzle clogging persists even after cleaning and nozzle washing.

● Menu List

Item	Setting ^{*1}	Details
Station	-	This moves the carriage to allow station and print head maintenance.
Carriage Out	-	
Move To Platen Right End	-	Cleans around the station, including the cap, wiper, and NCU.  "Wiper Cleaning"(P. 92)  "Cap Rubber Cleaning"(P. 93)  "NCU Cleaning"(P. 94)
Move To Maint. Space	-	Cleans around the print head.  "Carriage Underside Cleaning"(P. 95)  "Media Sensor Cleaning"(P. 98)  "Automatic Correction Sensor (DAS) Cleaning"(P. 96)
Nozzle Wash	1 to 99 min	Washes the print head nozzle surface with maintenance liquid to resolve print defects (e.g., nozzle clogging, deflection).  "Print Head Nozzle Washing"(P. 120)
Pump Tube Cleaning	-	Washes the suction pump tube (below the cap).  "Ink Discharge Channel Cleaning"(P. 97)
Custody Wash	1 to 99 min	Perform this step if the machine will not be used for extended periods. The function washes nozzles and drainage channels to maintain the machine in optimal condition.  "When Not in Use for Extended Periods"(P. 100)
Replace Wiper	-	Use this function when replacing the wiper. Replacing the wiper resets the wiper usage counter.  "Wiper Replacement"(P. 103)
Nozzle Recovery	-	Allows other nozzles to be used for printing if maintenance actions like nozzle washing fail to resolve print defects (e.g., nozzle clogging, deflection).
Print	-	Prints a pattern to check nozzle condition and register the nozzle.  "Registering nozzle recovery"(P. 76)
Entry	-	Registers the nozzle without printing a pattern.
Reset	-	Initializes the details set.
Check	-	Checks if nozzle recovery is possible for the registered nozzle.   "Checking whether nozzle recovery is set correctly"(P. 77)
Test printing	ON/OFF	Sets whether to perform nozzle recovery before test printing.
Auto Maint.	-	Sets various maintenance actions to be performed automatically. Set the interval between individual maintenance actions. <ul style="list-style-type: none"> If the warning message "Replace Wasteinktank" appears, the automatic maintenance function is disabled.  "Waste Ink Tank Replacement"(P. 113)
Refresh	0.5 to <u>4.0</u> h	Sets the refresh interval. <ul style="list-style-type: none"> Ejects a small amount of ink from the print head nozzles. This will help prevent nozzle clogging.
Cleaning Interval	1 to <u>12</u> h	Sets head cleaning intervals.

Item	Setting ^{*1}	Details
		<ul style="list-style-type: none"> Cleans the print head. This will help prevent nozzle clogging.
Cleaning Type	<u>Normal</u> / <u>Soft</u> / <u>Hard</u>	Sets the cleaning type for head cleaning.
Waste ink tank	-	Resets or corrects the waste ink tank usage count. "Waste Ink Tank Replacement"(P. 113)
FILL UP INK	-	Fills the ink to resolve printing defects (e.g., nozzle clogging, deflection).

*1. The default settings are shown underlined.

Registering nozzle recovery

Allows other nozzles to be used for printing if maintenance actions like nozzle washing fail to resolve print defects (e.g., nozzle clogging, deflection).



- Nozzle recovery can be specified for up to ten nozzles per row. The time taken for printing remains unchanged even when nozzle recovery is set.



- Load media at least 500 mm wide. You cannot print the entire pattern if media less than 500 mm wide is used.

- 1 Load the media.**
- 2 On the LOCAL mode screen, select [MENU] > [Maintenance], then press the [ENTER] key.**
 - The Maintenance menu is displayed.
- 3 Select [Nozzle Recovery] > [Print], then press the [ENTER] key.**
- 4 Select the head for nozzle recovery, then press the [ENTER] key.**
- 5 Select "Print Start", then press the [ENTER].**
 - Print a nozzle recovery pattern.
 - The Select Entry Nozzle screen appears once printing is complete.

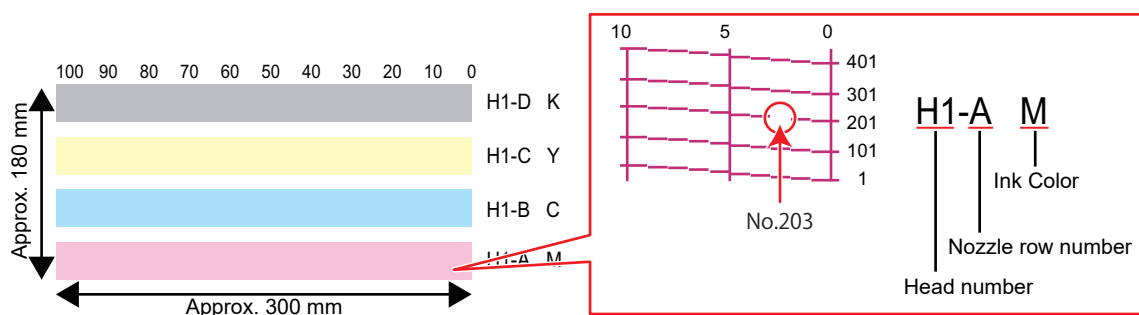

- 6** Select the “head number and nozzle row” for nozzle recovery, then press the [ENTER] key.

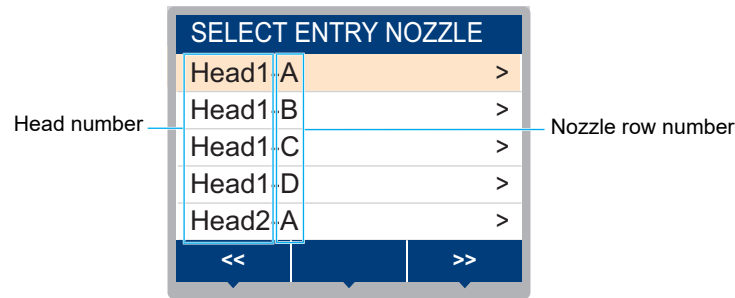

- 7** Enter the “nozzle number” for nozzle recovery, then press the [ENTER] key.

- Select the entry number before entering the nozzle number.
- Nozzle recovery is set.

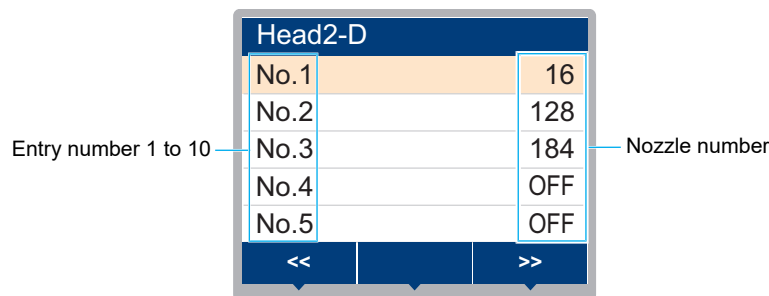

- 8** Press the [ENTER] key once entry is complete.



- Select [Maintenance] > [Nozzle Recovery] > [Test Print], then select “ON” to perform nozzle recovery and test printing.  ["Test Printing"\(P. 58\)](#)

Checking whether nozzle recovery is set correctly

- 1** Load the media.
- 2** In LOCAL mode, select [MENU] > [Maintenance], then press the [ENTER] key.
 - The Maintenance menu is displayed.
- 3** Select [Nozzle Recovery] > [Check], then press the [ENTER] key.
 - The Judgement screen will be displayed.
- 4** Enter the desired printing conditions.

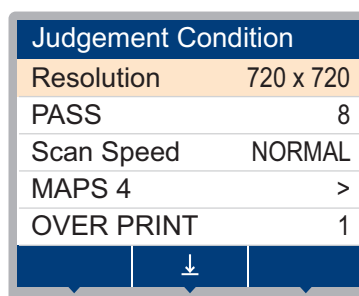

5 Press the [FUNC2] key.

- The judgment result is displayed.

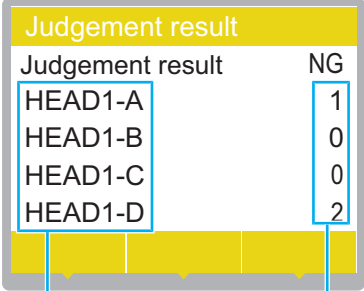
OK	No good										
 <p>A screenshot of a device display with a blue header 'Judgement result'. Below the header, the text 'Judgement result' is on the left and 'OK' is on the right. The display is shown with a wavy line at the bottom, indicating it is a screen capture.</p>	 <p>A screenshot of a device display with a yellow header 'Judgement result'. Below the header, the text 'Judgement result' is on the left and 'NG' is on the right. Below this, there is a list of nozzle rows and their corresponding counts:</p> <table border="1"> <thead> <tr> <th>Head number - nozzle row</th> <th>Number of nozzles that cannot be</th> </tr> </thead> <tbody> <tr> <td>HEAD1-A</td> <td>1</td> </tr> <tr> <td>HEAD1-B</td> <td>0</td> </tr> <tr> <td>HEAD1-C</td> <td>0</td> </tr> <tr> <td>HEAD1-D</td> <td>2</td> </tr> </tbody> </table> <p>Blue boxes highlight the nozzle rows and their counts. Blue lines point from the labels 'Head number - nozzle row' and 'Number of nozzles that cannot be' to the respective columns in the table above.</p>	Head number - nozzle row	Number of nozzles that cannot be	HEAD1-A	1	HEAD1-B	0	HEAD1-C	0	HEAD1-D	2
Head number - nozzle row	Number of nozzles that cannot be										
HEAD1-A	1										
HEAD1-B	0										
HEAD1-C	0										
HEAD1-D	2										

6 Press the [ENTER] key once entry is complete.

3.3 Machine setup menu

This is used to set various operations to ensure optimal machine performance.

● Menu List

Item	Setting ^{*1}	Details
Auto Power-off	None/5 min to <u>15 min</u> to 600 min	Sets the time until the power is automatically turned off.
Auto Power-on	-	Sets the time to automatically turn on the power.
SETUP	<u>ON/OFF</u>	Sets whether to turn on or off the power.
Time	<u>0:00</u> to 23:59	Sets the time to turn on the power.
Day of week	-	Sets whether to turn on or off the power on each day of the week.
Nozzle check	<u>ON/OFF</u>	Automatically executes the nozzle check function when the machine is started with auto power-on. Performs nozzle recovery (cleaning followed by nozzle checking) if “nozzle clogging” is detected.
Cleaning	<u>Soft/Normal/</u> Hard	Sets the cleaning type.
Retry Count	<u>0</u> to 3 times	Performs nozzle recovery (cleaning followed by nozzle checking) for the specified number of times.
Take-up Unit	-	Sets the take-up unit operation.
Take-up Unit	<u>ON/OFF</u>	Set to “OFF” if the take-up unit is not used.
Take-up SW	<u>Continuous/</u> Temporary	Sets the function performed by the ON/OFF button on the take-up unit in LOCAL mode. <ul style="list-style-type: none"> • Continuous: Press the button to start/stop the take-up unit. • Temporary: The take-up unit operates only while the button is pressed. The unit stops when the button is released.
Drying/Exhaust FAN	-	Set when the optional drying/exhaust fan is used. For more information, refer to the operation manual for the drying fan unit.
STOP TIME	<u>OFF/10 min</u> to 120 min	Sets the time during which the drying/exhaust fan operates after printing. After the set time passes, the fan stops.
ON/OFF	<u>ON/OFF</u>	Set to “ON” to operate the drying/exhaust fan when printing is not performed.
Top blower	<u>ON/OFF</u>	Sets the blowing fan operation during printing.
STRENGTH	<u>AUTO/Weak/</u> Standard	Sets the blowing fan wind strength.
Media Remain	<u>ON/OFF</u>	The remaining roll media amount can be displayed and printed out in REMOTE mode. <ul style="list-style-type: none"> • ON: An input screen appears once the media width is detected. <ul style="list-style-type: none"> ▲ Press ▼ to set the media length. Press the [FUNC3] key on the “Origin Setup” screen to print the date and remaining media amount. • OFF: The remaining media amount is not displayed.
Media Detect	-	Sets the media width detection method.
DETECTION TYPE	<u>AUTO/</u> MANUAL	<ul style="list-style-type: none"> • AUTO: The media width is automatically detected with the sensor. • MANUAL: ◀ Press ▶ to set the media width manually.

Item	Setting ^{*1}	Details
		– When using media that cannot be detected using AUTO, set to "MANUAL".
At Startup	ON/OFF	The medium is detected automatically when the clamp lever is lowered after the machine starts up. Set to "OFF" if auto detection is not required.
Detect Speed	Fast/Standard	<ul style="list-style-type: none"> • Fast: Clear or reflective media may not be detected. If detection is unsuccessful, select "Standard". • Standard: Select "Standard" if the medium is not detected successfully.
LANGUAGE	English/ Japanese/ Chinese	Sets the display language.
Time Set	-20 h to 0 to +4 h	Sets the current time and date. (With respect to JST) <ul style="list-style-type: none"> • This can be set within the range of -20 to +4 hours.
UNIT / TEMP	°C/°F	Sets the display unit for temperature (Celsius/Fahrenheit).
UNIT / LENGTH	mm/inch	Sets the display units for length and area. <ul style="list-style-type: none"> • Some items are displayed in "mm" even if "inches" is selected.
600cc cartridge	-	Displayed when the 600ml ink cartridge is used in the ink supply unit.
Case weight	-	Registers the ink IC chip and the weight of the attached 600ml ink cartridge case. 🖨️ "Replace with a new ink cartridge"(P. 82)
Cartridge weight	-	Registers the weight of the 600ml ink cartridge with the ink pack being set. 🖨️ "Correcting the Ink Cartridge Case Weight"(P. 83)
Key Buzzer	ON/OFF	Sets an audible tone when keys are pressed. <ul style="list-style-type: none"> • Audible signals indicating errors, warnings, and operation end cannot be muted, even if "OFF" is selected for this setting.
View Feed	ON/OFF	Sets whether or not to feed the media forward to view the print results—for example, during test printing.
Space Btwn PP.	None/10 to 500 mm	Setting the distance of the reverse feed (spaces between prints) during continuous printing can eliminate spaces between prints. <ul style="list-style-type: none"> • The reverse feed may cause sagging media, resulting in discrepancies in the distance the media is fed. If this occurs, rewind the media by hand to eliminate sagging before printing.
Space Feed Mode	Intermittent/ Continuous	Alters the feed method for blank space included in the image data. <ul style="list-style-type: none"> • Intermittent: Uses intermittent feeding based on the timing of a fraction of the pass. • Continuous: Feeds forward by skipping blank parts.
Network	-	Sets the network address. The machine must be restarted to enable this setting.
Check IP Address	-	Displays the machine's current IP address. <ul style="list-style-type: none"> • It may take some time to determine the IP address. If the IP address cannot be determined, the display will indicate "0.0.0.0".
Check MAC Address	-	Displays the machine's current MAC address.
DHCP	ON/OFF	Select "ON" to use the IP address assigned by the DHCP server.
AutoIP	ON/OFF	Select "ON" to use the IP address set by the AutoIP protocol. Note that DHCP takes priority if DHCP is set to "ON".
IP Address	-	Sets the machine's IP address.

Item	Setting ^{*1}	Details
		<ul style="list-style-type: none"> This can be set when both [DHCP] and [AutoIP] are set to "OFF".
Default Gateway	-	Sets the machine's default gateway. <ul style="list-style-type: none"> This can be set when both [DHCP] and [AutoIP] are set to "OFF".
DNS Address	-	Sets the machine's DNS server address. <ul style="list-style-type: none"> This can be set when both [DHCP] and [AutoIP] are set to "OFF".
Sub Net Mask	-	Sets the number of subnet mask digits used by this machine. <ul style="list-style-type: none"> This can be set when both [DHCP] and [AutoIP] are set to "OFF".
Event Mail	-	An email can be sent to a specified email address when an event (e.g., print start, print end, and abort) occurs. The machine must be restarted to enable this setting. 📧 "Event Email Function Settings"(P. 84)
Mail Delivery	ON/OFF	Sets whether event emails are sent.
Select Event	-	
Print Start Event	ON/OFF	Sets whether an email is sent when printing starts.
Print End Event	ON/OFF	Sets whether an email is sent when printing ends.
Plot Start Event	ON/OFF	Sets whether an email is sent when cutting starts.
Plot End Event	ON/OFF	Sets whether an email is sent when cutting ends.
Error	ON/OFF	Sets whether an email is sent when an error occurs.
Warning	ON/OFF	Sets whether an email is sent when a warning occurs.
Other Event	ON/OFF	Set to send or not send an email when an event other than those listed above occurs.
Mail Address	-	Sets the email address to which emails will be sent (not to exceed 96 alphanumeric characters or symbols).
Message Subject	-	Sets the characters contained in a message subject (not to exceed 8 alphanumeric characters or symbols).
Server Setup	-	
SMTP Address	-	Sets the SMTP server.
SMTP Port No.	-	Sets the SMTP port number.
Sender Address	-	Sets the sender address (not to exceed 64 alphanumeric characters or symbols). <ul style="list-style-type: none"> Setting an email address corresponding to the server account allows emails to be sent.
Authentication	OFF/POP before SMTP/SMTP authentication	Sets the SMTP server authentication method.
User Name	-	Sets the user name used for authentication (not to exceed 30 alphanumeric characters or symbols). <ul style="list-style-type: none"> This can be set when [Authentication] is not set to "OFF".

Item	Setting ^{*1}	Details
Pass Word	-	Sets the password used for authentication (not to exceed 15 alphanumeric characters or symbols). • This can be set when [Authentication] is not set to "OFF".
POP3 Address	-	Sets the POP server. • This can be set when [Authentication] is set to "POP before SMTP".
APOP	-	Enables or disables APOP. • This can be set when [Authentication] is set to "POP before SMTP".
Transmit Test	-	Sends a test email.  "Transmit Test"(P. 84)
Auto Remote	<u>ON/OFF</u>	Sets whether to automatically switch to REMOTE mode and start printing if data is received locally.
Feeding Before Cut	<u>ON/OFF</u>	Sets whether to feed media before cutting the media.
Reset	-	Initializes the details set.

*1. The default settings are shown underlined.

Registering and Correcting a 600 ml Ink Cartridge

● Required Items

Name	Outline
600 ml ink cartridge case	The 600 ml ink pack and the ink IC chip provided with the ink pack are placed in the 600 ml ink cartridge case.
600 ml ink pack	
Ink IC chip	
Scale	The weight of the 600 ml ink cartridge is registered to calculate the amount of remaining ink. Use a scale capable of weighing in 1 g increments.

Replace with a new ink cartridge

Register the case weight.



- If you replace the ink cartridge case, you need to re-register it.

1 Weigh the 600 ml ink cartridge case.



- Do not install the ink pack or the ink IC chip at this point.

2 Set the ink pack and ink IC chip into the 600ml ink cartridge case.

-  ["Replacing Ink"\(P. 40\)](#)

3 Insert the 600 ml ink cartridge in the ink supply unit.

4 On the LOCAL mode screen, select [MENU] > [Machine Setup], then press the [ENTER] key.

- The Machine Setup menu is displayed.

- 5** Select [600cc cartridge] > [Case Weight], then press the [ENTER] key.
- 6** Select the required ink slot, then press the [ENTER] key.
 - The selected slot is highlighted.
- 7** Enter the measured weight of the 600 ml ink cartridge case, then press the [ENTER] key.



- Check the following when "ERROR614 Preservation Failure" appears:
 - (1) Check to confirm that the 600ml ink cartridge was fully inserted.
 - (2) Check to confirm the ink IC chip was installed correctly.

Correcting the Ink Cartridge Case Weight

When the remaining ink level in the 600 ml ink cartridge reaches a preset level, [Ink Level Low], [Ink Near End], [Ink Level End], or [Ink End] appears on the display. The weight may differ from the actual weight, so the weight of the 600 ml ink cartridge should be corrected.



- If non-actual weights are registered repeatedly, the ink IC chip can no longer be used.
- Continuous printing is not possible when the warning is displayed.
- Replace with a new ink pack when "Replace Inkpack" is displayed.

- 1** A warning appears on the display.
- 2** Remove the 600 ml ink cartridge case in the indicated ink slot, and measure the weight.



- Weight with the ink pack inserted.

- 3** Insert the 600 ml ink cartridge in the ink supply unit.
 - The cartridge weight screen appears.

- 4** Enter the measured weight of the 600 ml ink cartridge, then press the [ENTER] key.
 - The remaining ink amount of the ink pack is calculated and saved in the ink IC chip.
 - The weight of the 600ml ink cartridge can be registered as follows:
 - (1) On the LOCAL mode screen, select [MENU] > [Machine Setup], then press the [ENTER] key.
 - The Machine Setup menu is displayed.
 - (2) Select [600cc cartridge] > [Cartridge Weight], then press the [ENTER] key.
 - (3) Select the required ink slot, then press the [ENTER] key.
 - The selected slot is highlighted.
 - (4) Enter the measured weight of the 600 ml ink cartridge, then press the [ENTER] key.



- Check the following when "ERROR614 Preservation Failure" appears:
 - (1) Check to confirm that the 600ml ink cartridge was fully inserted.
 - (2) Check to confirm the ink IC chip was installed correctly.

- 5** Open the cover of the ink cartridge and bend the ink pack.



- When the Ink cartridge check appears, be sure to open the cover of the ink cartridge and bend the ink pack. If you continue printing without folding the ink pack, there is a risk that ink will not be ejected.

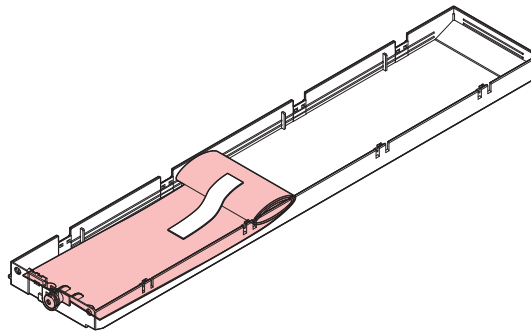

Event Email Function Settings

An email can be sent to a specified email address when an event (e.g., print start, print end, and abort) occurs.



- SSL (Secure Socket Layer) encoding is not supported.



- Connect the LAN cable to use the event mail function.
["Using a LAN Cable"\(P. 32\)](#)

Disclaimers

- Internet communication charges for email notifications, etc. are the responsibility of the customer.
- Event emails may not be delivered if problems arise with the Internet setup or equipment. Mimaki rejects all liability for damages resulting from delivery failure or delay.

Transmit Test

- 1** On the LOCAL mode screen, select [MENU] > [Machine Setup], then press the [ENTER] key.
 - The Machine Setup menu is displayed.
- 2** Select [Event Mail] > [Transmit Test], then press the [ENTER] key.
- 3** Press the [ENTER] key.
 - The transmission results are displayed.
 - An error code will be displayed if the test email transmission is unsuccessful. Refer to the error code list and take appropriate action.

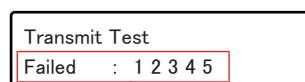

Error code



- Emails may not necessarily be delivered even if they have been sent. Check the terminal receiving the email for spam email filters.
- For more information on server settings or other topics, contact your network administrator or service provider.

- 4** Press the [ENTER] key once the test is complete.

● Error Code List

Error code	Likely cause	Corrective action
10	Network connection error	<ul style="list-style-type: none"> • Check to confirm that this machine is connected to a network. • Check the IP address for this machine. • Check if the network setup allows this machine to use DNS.
20	No valid email address	<ul style="list-style-type: none"> • Enter a valid email address.
11003 11004	No POP server could be found. or the DNS server could not be accessed.	<ul style="list-style-type: none"> • Check the POP server address. • Check if the network setup allows this machine to use DNS.
11021	Unable to connect to POP server	<ul style="list-style-type: none"> • Check the POP server settings. • Check the firewall settings.
12010	An error was returned from the POP server.	<ul style="list-style-type: none"> • Check the POP server settings.
13000	POP authentication failed.	<ul style="list-style-type: none"> • Check the user name and password. • Check the APOP settings. • Check the authentication method.
10013 10014	No SMTP server could be found. or the DNS server could not be accessed.	<ul style="list-style-type: none"> • Check the SMTP server address. • Check if the network setup allows this machine to use DNS.
10021	Unable to connect to SMTP server	<ul style="list-style-type: none"> • Check the SMTP server settings. • Check the SMTP port number. • Check the firewall settings.
10*** 11*** 20*** 21***	An error was returned from the SMTP server. or there was no response.	<ul style="list-style-type: none"> • Check the SMTP server settings. • Communication is not possible with a server that requires SSL communication. • Check the protocol filter settings.
12***	The sender email address is invalid.	<ul style="list-style-type: none"> • Set an email address corresponding to the server account.
13***	The email recipient could be found or the email address is invalid.	<ul style="list-style-type: none"> • Check the email address. • This error may not always be detected even if the email address is incorrect. • Set an email address corresponding to the server account.
22000 22008	SMTP authentication error	<ul style="list-style-type: none"> • Check the authentication method.
23*** 24*** 25***	SMTP authentication failed.	<ul style="list-style-type: none"> • Check the user name and password.

1. *** is the error code received from the mail server



- If the error persists, wait a while before retrying.

3.4 Nozzle check menu

This is used to check if the nozzles are clogged before printing. Sets whether to perform maintenance functions automatically if nozzle clogging is detected.

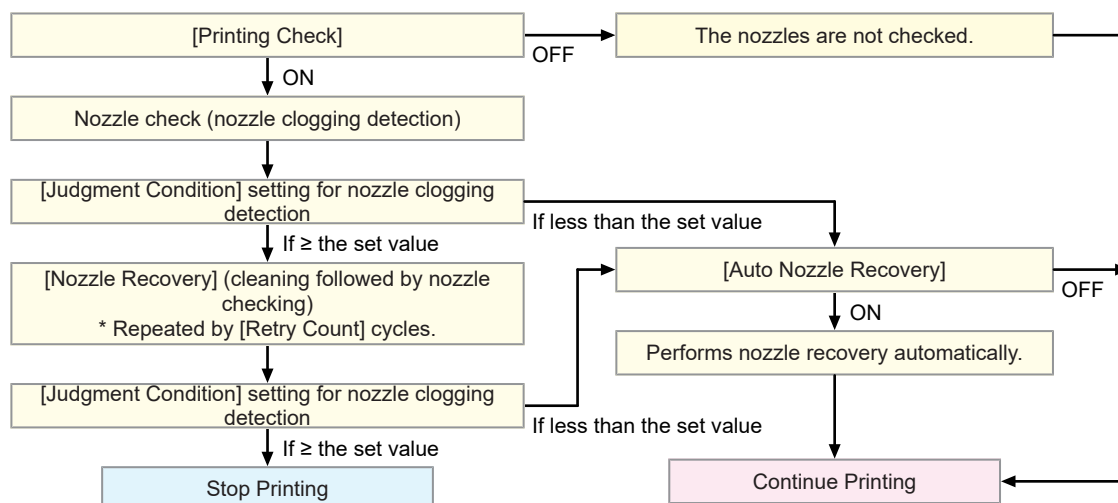

● Menu List

Item	Setting ^{*1}	Details	
Printing Check	ON/OFF	Performs nozzle clogging detection before printing starts.	
Check Interval	-	Sets the nozzle clogging detection timing.	
	Length	0.1 m to <u>30.0</u> m to 100.0 m	Performs nozzle clogging detection after the length set is reached and before the next print starts.
	File	1 to <u>30</u> to 1,000 files	Performs nozzle clogging detection after the preset number of files has been printed and before the next print starts.
	Action	-	Performs nozzle recovery (cleaning followed by nozzle checking) if "nozzle clogging" is detected.
	Cleaning	<u>Soft</u> /Normal/ Hard	Sets the cleaning type.
	Retry Count	<u>0</u> to 3 times	Performs nozzle recovery (cleaning followed by nozzle checking) for the specified number of times.
Auto Nozzle Recovery	ON/OFF	Performs nozzle recovery automatically if "nozzle clogging" is detected. See below if you wish to perform nozzle recovery manually. "Registering nozzle recovery"(P. 76)	
Judgment Condition ^{*2}	OFF / 1 to <u>10</u> to 100 nozzles	Set the number of nozzles per row to be detected as clogged before "nozzle clogging" is detected. The next print will not start if "nozzle clogging" is detected during continuous printing.	

*1. The default settings are shown underlined.

*2. Nozzle recovery is not available for certain print conditions.



- If an error occurs during the nozzle check operation, the next print will be automatically stopped, and [Printing Check] will be set to "OFF". Clear the error, then set [Printing Check] to "ON" manually.

3.5 Information menu

This is used to check machine information.

● Menu List

Item		Details
Usage	Wiping	Displays the wiping count. <ul style="list-style-type: none"> To reset this count, press the [FUNC2] key while the count is displayed.
	Waste ink tank	Displays the approximate level of waste ink in the waste ink tank as a percentage. <ul style="list-style-type: none"> To reset waste ink levels, press the [FUNC1] key while the level is displayed.
	Print Length	Displays the total length printed.
	Print Area	Displays the total area printed.
	Use Time	Displays the total time the power has been turned on.
Version		Displays the machine firmware and other versions.
Error History		Displays the error and warning history. <ul style="list-style-type: none"> These are listed in chronological order. Use the keys to cycle through occurrence time/date and error/warning information.
List		This is used to print machine information.

Chapter 4 Maintenance



This chapter

The machine should be cleaned periodically depending on the usage frequency to maintain accuracy and ensure long-term use.

Read the maintenance precautions thoroughly before maintaining this product.

Maintenance Precautions	90	Consumable Item Replacement	103
Maintenance Procedure	91	Wiper Replacement	103
Maintenance Items and Timing	91	Wiper Cleaner Replacement	104
Ink Maintenance	91	Cap Replacement	105
Wiper Cleaning	92	Cap Absorber Replacement	106
Cap Rubber Cleaning	93	Blowing Fan Filter Replacement	108
NCU Cleaning	94	Pinch Roller Replacement	108
Carriage Underside Cleaning	95	Media Holder Replacement	109
Automatic Correction Sensor (DAS) Cleaning	96	Media Cutter Replacement	111
Ink Discharge Channel Cleaning	97	Waste Ink Tank Replacement	113
Media Sensor Cleaning	98		
Media Holder Cleaning	98		
Platen Cleaning	99		
Cover (Exterior) Cleaning	100		
When Not in Use for Extended Periods ...	100		

4.1 Maintenance Precautions



- This machine includes parts that must be replaced periodically. We therefore recommend taking out a maintenance contract. Clean this machine and replace consumable items to prevent quality defects and accidents.

⚠ WARNING



- Clean periodically. Debris and dust will accumulate on electrical components when this machine is used for extended periods. There is a risk of failure, electric shock, or fire due to current leakage.
- Do not clean by blowing—e.g., avoid using air blowers. Doing so may lead to failure, electric shock, or fire involving the machine if airborne debris or dust gets inside electrical components. Wipe using a soft cloth soaked in dilute detergent and thoroughly wrung out. A vacuum cleaner may also be used for cleaning.



- Do not allow liquids to get inside the product. Otherwise there is a risk of failure, electric shock, or fire.

⚠ CAUTION



- For heavy soiling, wipe using a soft cloth soaked in dilute detergent and thoroughly wrung out.



- Pay close attention to ventilation and be sure to wear safety glasses, gloves, and a mask when handling ink, maintenance liquid, waste ink, or other solutions used with this machine. Leaking ink may adhere to the skin or get into the eyes or mouth.



NOTICE



- Never touch the print head nozzle surface. Do not allow water or alcohol to come into contact with the print nozzle surface. This will increase the risk of machine failure or printing defects (e.g., nozzle clogging or deflection).
- Do not use cotton swabs to clean around the head or carriage. Fibers from cotton swabs may adhere to the head nozzle surface and lead to printing defects (e.g., nozzle clogging or deflection).
- Be careful to avoid splashing ink or maintenance liquid on the covers. Exposure to splashing ink or maintenance liquid may damage or deform the cover.
- Do not use benzine, thinner, or any chemical agent containing abrasives. Use of these chemicals may result in damage to or deformation of parts.
- Do not move the carriage by hand. To move the carriage, use the carriage out function on the menu.

4.2 Maintenance Procedure

Maintenance Items and Timing

Timing	Item
Periodically	Shake the Ink cartridge. "Ink Maintenance"(P. 91)
At the end of the work week	Clean the wiper and wiper bracket. "Wiper Cleaning"(P. 92)
	Clean the cap rubber. "Cap Rubber Cleaning"(P. 93)
	Clean the NCU. "NCU Cleaning"(P. 94)
	Clean the underside of the carriage. "Carriage Underside Cleaning"(P. 95)
	Clean the DAS sensor. "Automatic Correction Sensor (DAS) Cleaning"(P. 96)
	Clean the ink discharge channel. "Ink Discharge Channel Cleaning"(P. 97)
	Clean the media sensor. "Media Sensor Cleaning"(P. 98)
	Clean the media holder. "Media Holder Cleaning"(P. 98)
	Clean the platen. "Platen Cleaning"(P. 99)
	Clean the cover (exterior). "Cover (Exterior) Cleaning"(P. 100)
	Check the waste ink levels in the waste ink tank. "Replacing the Waste Ink Tank"(P. 113)
When not used for more than a week	Clean the wiper and cap and wash the ink discharge channels. After cleaning, store without turning off the main power supply. "When Not in Use for Extended Periods"(P. 100)

Items Required for Maintenance

To order replacement consumable items, contact your local dealer or our service office.

For more information on consumable items, refer to our website. <https://mimaki.com/supply/inkjet.html>



- Avoid storing this product in locations accessible to children.

Ink Maintenance

If ink constituents are sedimented, the ink density may become uneven. We recommend shaking the Ink cartridge periodically to keep printing consistent.

Solvent ink: once a month.

Orange ink: once a week.

● Orange Ink

Every 24 hours, the display will show "Shake the orange ink cartridge". If the message appears, shake the orange ink cartridge.

● Shake the Ink cartridge

1 Shake the Ink cartridge to the left and right slowly at least 20 times.

- Shake the case slowly from left to right to ensure that the ink moves inside.

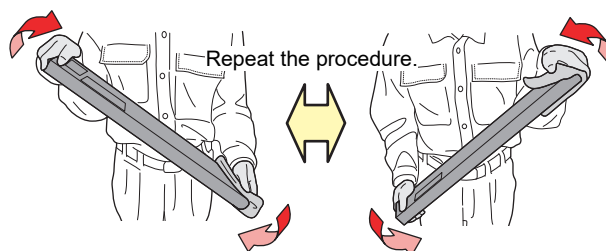

- If the ink cartridge is partially used, flip the ink cartridge upright and shake slowly at an angle, holding the ink cartridge slot with a paper towel.



Needle slot

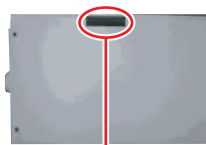

Gap on the side

Wiper Cleaning

The wiper wipes off ink adhering to the print head nozzle surface. Continuing to use the dirty wiper may cause the wiper to which dried ink and dust are attached to rub against the nozzle surface, leading to printing defects (e.g., nozzle clogging or deflection).



- Be careful to avoid leaving fragments from the cleaning stick behind when cleaning. These fragments will increase the risk of printing defects (e.g., nozzle clogging or deflection).

1 On the LOCAL mode screen, select [MENU] > [Maintenance], then press the [ENTER] key.

- The Maintenance menu is displayed.

2 Select [Station] > [Carriage Out] > [Move To Platen Right End], then press the [ENTER] key.

- The carriage moves over the platen.

3 Open the front cover.

4 Remove the wiper.

- Hold the lug at the rear of the wiper bracket, then pull out the wiper.

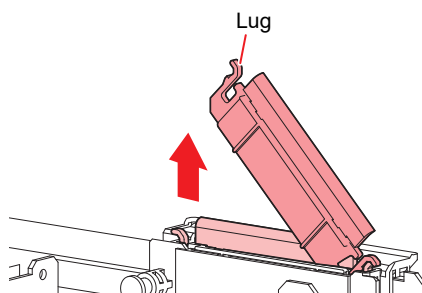

5 Clean the wiper and bracket.

- Wipe off any ink and dust adhering using a cleaning stick moistened with maintenance liquid. Wipe off the maintenance liquid. Make sure none remains.

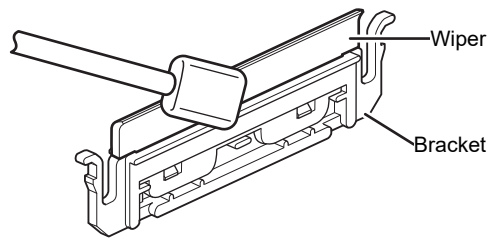

- Replace dirty or warped wipers with new ones. 🖱️ ["Wiper Replacement"\(P. 103\)](#)

6 Clean the wiper slider.

- Wipe off any ink and dust adhering using a cleaning stick moistened with maintenance liquid. Wipe off the maintenance liquid. Make sure none remains.

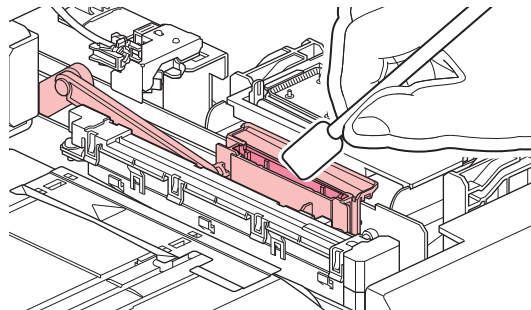

7 Reattach the wiper at the original position.

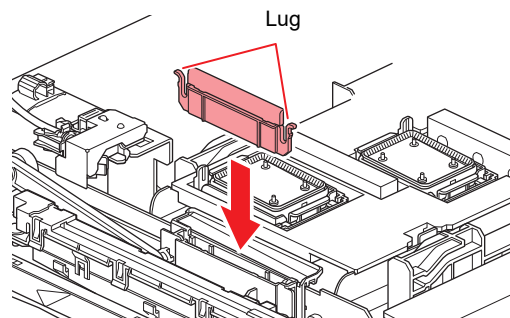

- Do not remove the absorbent material in the absorbent material case. Doing so may result in leaking ink.

8 Once cleaning is complete, close the cover, then press the [ENTER] key.

Cap Rubber Cleaning

The cap prevents the print head nozzle surface from drying out. Continuing to use a dirty cap may affect ink take-up and lead to print defects (e.g., nozzle clogging, deflection).



- Be careful to avoid leaving fragments from the cleaning stick behind when cleaning. These fragments will increase the risk of printing defects (e.g., nozzle clogging or deflection).

- 1 On the LOCAL mode screen, select [MENU] > [Maintenance], then press the [ENTER] key.
 - The Maintenance menu is displayed.
- 2 Select [Station] > [Carriage Out] > [Move To Platen Right End], then press the [ENTER] key.
 - The carriage moves over the platen.
- 3 Open the front cover.
- 4 Clean the cap rubber.
 - Wipe off any ink and dust adhering using a cleaning stick moistened with maintenance liquid. Wipe off the maintenance liquid. Make sure none remains.

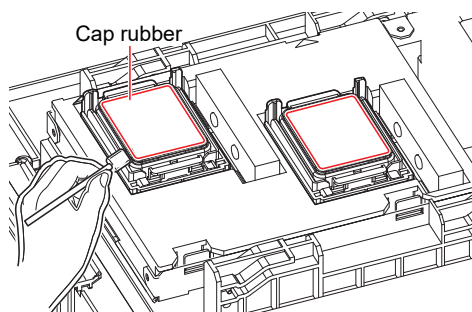

- 5 Check to confirm that the cap slider is not tilted once cleaning is complete.



- If the cap slider is tilted, move the slider block to the left or right to correct the tilt.

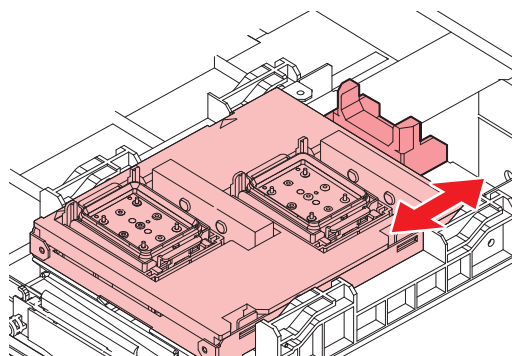

- 6 Close the front cover, then press the [ENTER] key.

NCU Cleaning

The NCU uses a sensor to monitor the ink droplets ejected from the print head nozzles. Continuing to use the dirty NCU may prevent the nozzle check function from operating correctly.



- Be careful to avoid leaving fragments from the cleaning stick behind when cleaning. These fragments will increase the risk of printing defects (e.g., nozzle clogging or deflection).

- 1 On the LOCAL mode screen, select [MENU] > [Maintenance], then press the [ENTER] key.
 - The Maintenance menu is displayed.
- 2 Select [Station] > [Carriage Out] > [Move To Platen Right End], then press the [ENTER] key.
 - The carriage moves over the platen.

3 Open the front cover.

4 Clean the NCU.

- Wipe off any ink and dust adhering using a cleaning stick moistened with maintenance liquid. Wipe off the maintenance liquid. Make sure none remains.

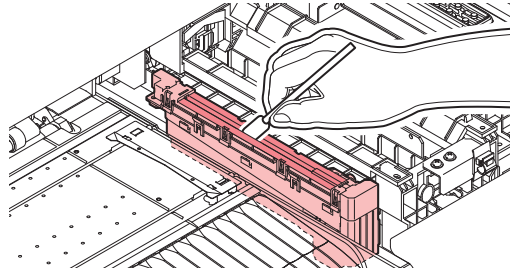

- Insert the cleaning stick as far as the line shown in the illustration.

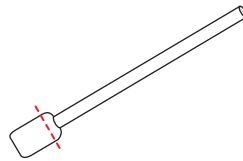

5 Once cleaning is complete, close the cover, then press the [ENTER] key.

Carriage Underside Cleaning

The underside of the carriage becomes coated with ink wiped off by the wiper. Continuing to use the dirty carriage underside will rub dried ink and attached dust on to the media, resulting in contaminated prints.

The print head uses an extremely delicate mechanism. Take great care when handling it.



- Be careful to avoid leaving fragments from the cleaning stick behind when cleaning. These fragments will increase the risk of printing defects (e.g., nozzle clogging or deflection).

1 On the LOCAL mode screen, select [MENU] > [Maintenance], then press the [ENTER] key.

- The Maintenance menu is displayed.

2 Select [Station] > [Carriage Out] > [Move To Maint. Space], then press the [ENTER] key.

- The carriage moves to the maintenance space.

3 Open the maintenance covers.

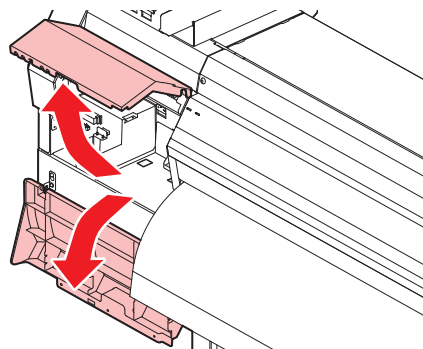

4 Clean around the print head.

- Wipe off any ink and dust adhering using a cleaning stick moistened with maintenance liquid. Wipe off the maintenance liquid. Make sure none remains.

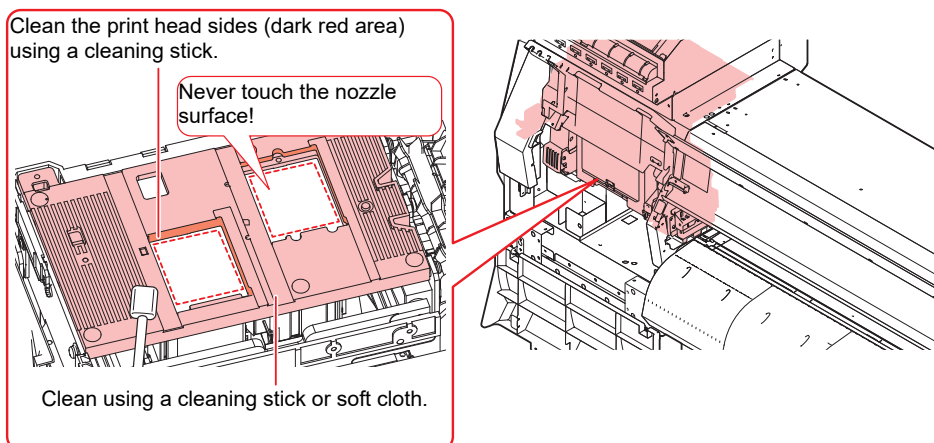

- Never touch the print head nozzle surface.

5 Once cleaning is complete, close the cover, then press the [ENTER] key.

Automatic Correction Sensor (DAS) Cleaning

The DAS sensor is located on the carriage underside. If dust or debris accumulates on the sensor, an error may occur in the automatic correction function (Automatic correction of drop position).

- 1 On the LOCAL mode screen, select [MENU] > [Maintenance], then press the [ENTER] key.
 - The Maintenance menu is displayed.
- 2 Select [Station] > [Carriage Out] > [Move To Maint. Space], then press the [ENTER] key.
 - The carriage moves to the maintenance space.
- 3 Open the maintenance covers.

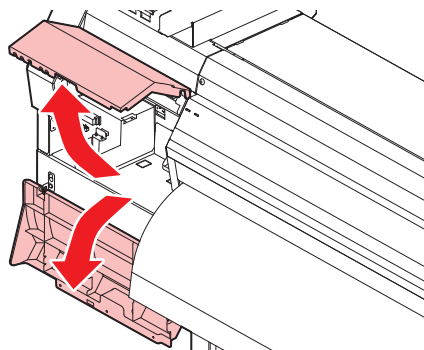

4 Clean the DAS sensor.

- Wipe clean using cotton swabs or a soft cloth.

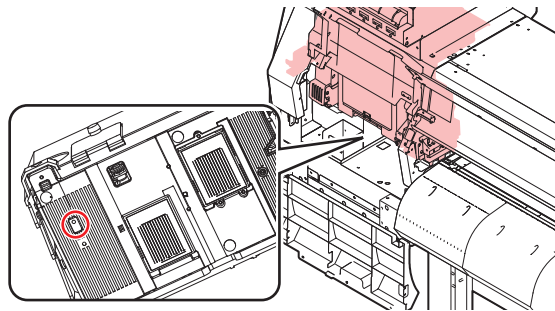

- For heavy soiling, wipe using a soft cloth soaked in dilute detergent and thoroughly wrung out.

5 Once cleaning is complete, close the cover, then press the [ENTER] key.

Ink Discharge Channel Cleaning

Clean the ink discharge channel regularly to prevent clogging of the ink discharge channel below the cap.

1 On the LOCAL mode screen, select [MENU] > [Maintenance], then press the [ENTER] key.

- The Maintenance menu is displayed.

2 Select [Station] > [Disway Wash], then press the [ENTER] key.

- The cap is filled with maintenance liquid.



- Close the front cover. The cap cannot be filled with maintenance liquid unless the front cover is closed. This is also true if the maintenance liquid cartridge is empty.

3 Open the front cover.

- Check to confirm that the cap is filled with maintenance liquid.



- If not, use a syringe to draw up some maintenance liquid and fill until it almost overflows from the cap.

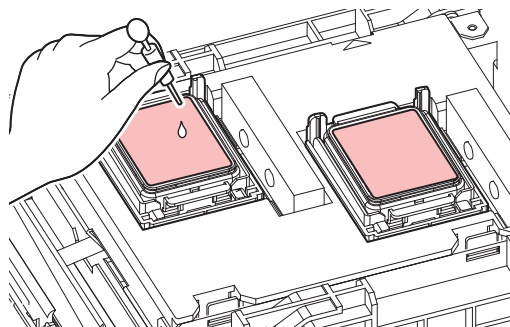

4 Close the front cover, then press the [ENTER] key.

- Pump tube (ink discharge channel below the cap) washing starts.

Media Sensor Cleaning

Media sensors are located on the rear cover and carriage underside. The media cannot be detected correctly if dust or debris accumulates on the sensors. Remove any debris using cotton swabs or a soft cloth.

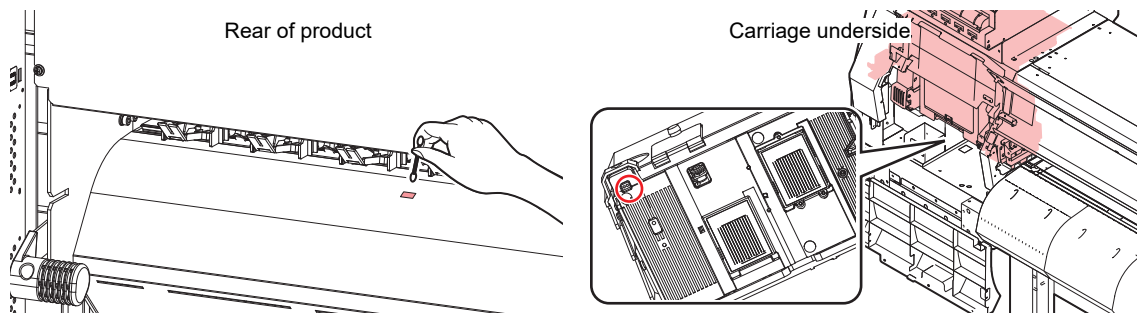

● Cleaning the carriage underside sensor

- 1** On the LOCAL mode screen, select [MENU] > [Maintenance], then press the [ENTER] key.
 - The Maintenance menu is displayed.
- 2** Select [Station] > [Carriage Out] > [Move To Maint. Space], then press the [ENTER] key.
 - The carriage moves to the maintenance space.
- 3** Open the maintenance covers.

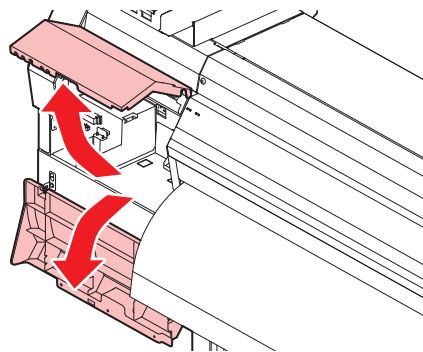

- 4** Clean the media sensor.
- 5** Once cleaning is complete, close the cover, then press the [ENTER] key.

Media Holder Cleaning



- Turn off the main power and unplug the power cable before carrying out maintenance.



- Do not allow liquids to get inside the product. Otherwise there is a risk of failure, electric shock, or fire.

Continuing to use the dirty platen will prevent proper feeding of the media. It will also cause dried ink and attached dust to rub against the head nozzle surface and lead to print defects (e.g., nozzle clogging, deflection).

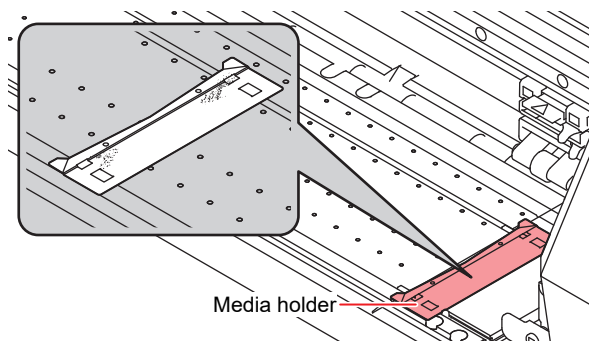

- For heavy soiling, wipe using a soft cloth soaked in dilute detergent and thoroughly wrung out.

Platen Cleaning



- Turn off the main power and unplug the power cable before carrying out maintenance.



- Do not allow liquids to get inside the product. Otherwise there is a risk of failure, electric shock, or fire.

Continuing to use the dirty platen will prevent proper feeding of the media. It will also cause dried ink and attached dust to rub against the head nozzle surface and lead to print defects (e.g., nozzle clogging, deflection).

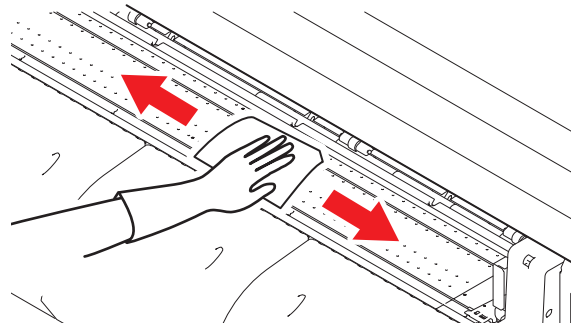

- The grooves in which the media holder slides and the media is cut are susceptible to dust accumulation. Remove any debris carefully.



- For heavy soiling, wipe using a soft cloth soaked in dilute detergent and thoroughly wrung out.

Cover (Exterior) Cleaning



- Do not allow liquids to get inside the product. Otherwise there is a risk of failure, electric shock, or fire.

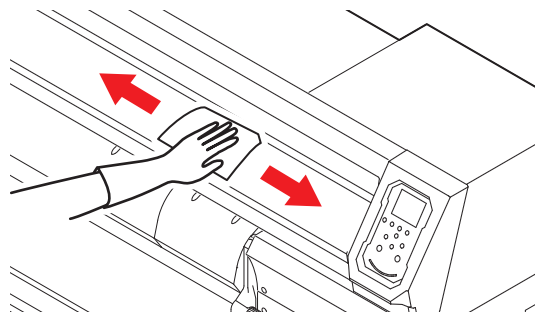

- For heavy soiling, wipe using a soft cloth soaked in dilute detergent and thoroughly wrung out.



When Not in Use for Extended Periods

Clean as follows if the product is not used for one week or longer:

Check beforehand

Is [Near End] or [Ink End] displayed?

- Maintenance liquid and ink is aspirated during the washing operation. Washing is not possible if an error occurs during this process. Replace with new ink.

- 1 On the LOCAL mode screen, select [MENU] > [Maintenance], then press the [ENTER] key.**
 - The Maintenance menu is displayed.
- 2 Select [Station] > [Custody Wash], then press the [ENTER] key.**
 - The carriage moves over the platen.
- 3 Open the front cover.**
- 4 Clean the wiper and bracket.**
 -  ["Wiper Cleaning"\(P. 92\)](#)
- 5 Press the [ENTER] key once cleaning is complete.**
 - "Cap Cleaning Completed (Next)[ENT]" appears on the display.
- 6 Clean the cap rubber.**
 -  ["Cap Rubber Cleaning"\(P. 93\)](#)
- 7 Once cleaning is complete, close the cover, then press the [ENTER] key.**
 - The cap is filled with maintenance liquid.



- Close the front cover. The cap cannot be filled with maintenance liquid unless the front cover is closed. This is also true if the maintenance liquid cartridge is empty.

8 Open the front cover.

- Check to confirm that the cap is filled with maintenance liquid.

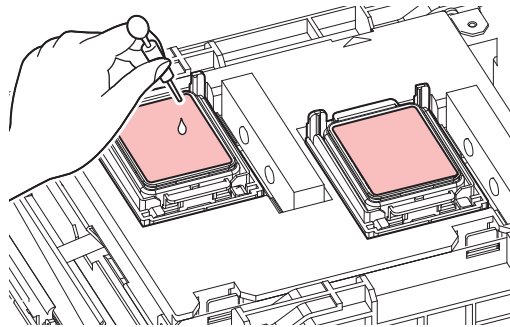

- If not, use a syringe to draw up some maintenance liquid and fill until it almost overflows from the cap.

**9 Close the front cover.****10 Set the exposure time, then press the [ENTER] key.**

- Print nozzle washing starts. The elapsed time is displayed on the display.
- Cleaning is performed automatically once print nozzle washing has ended.
- The cap is filled with maintenance liquid.



- Close the front cover. The cap cannot be filled with maintenance liquid unless the front cover is closed. This is also true if the maintenance liquid cartridge is empty.

11 Open the front cover.

- Check to confirm that the cap is filled with maintenance liquid.

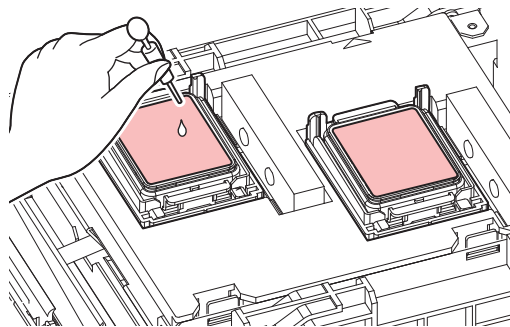

- If not, use a syringe to draw up some maintenance liquid and fill until it almost overflows from the cap.

**12 Close the front cover, then press the [ENTER] key.**

- Pump tube (ink discharge channel below the cap) washing starts.



- Do not turn off the main power supply. Turning off the main power supply will disable the automatic maintenance function (including nozzle clogging prevention function and ink discharge channel cleaning function). This will increase the risk of print defects (e.g., nozzle clogging, deflection).

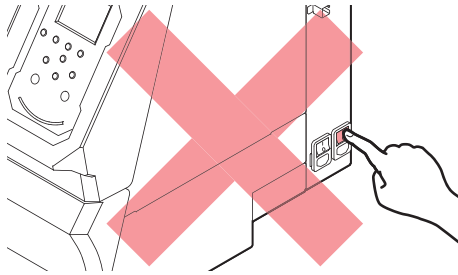

- Do not leave media loaded on the platen. This may leave irregularities or ripples in the media.



- When this product is not in use, raise the clamp lever to separate the pinch rollers from the grit rollers. Leaving the pinch rollers in the lowered position for an extended period of time may cause the pinch rollers to become deformed. Deformation of the pinch rollers may prevent the media from being fed correctly.



- Perform the following if the "Check Waste Ink Tank" message appears on the display.
☞ ["Waste Ink Tank Replacement"](#)(P. 113)

4.3 Consumable Item Replacement

To order replacement consumable items, contact your local dealer or our service office.

For more information on consumable items, refer to our website. <https://mimaki.com/supply/inkjet.html>



- When disposing of the product, contact an industrial waste disposal operator or dispose of the product in accordance with the local laws and regulations.



- Avoid storing this product in locations accessible to children.

Wiper Replacement

This product maintains a count of the number of wiping cycles. The “Replace Wiper” message appears when a preset count is reached. Replace dirty or warped wipers with new ones.

- 1 “Replace Wiper” appears on the display.
- 2 On the LOCAL mode screen, select [MENU] > [Maintenance], then press the [ENTER] key.
 - The Maintenance menu is displayed.
- 3 Select [Station] > [Replace Wiper], then press the [ENTER] key.
 - The carriage moves over the platen.
- 4 Open the front cover.
- 5 Remove the wiper.
 - Hold the lug at the rear of the wiper bracket, then pull out the wiper.

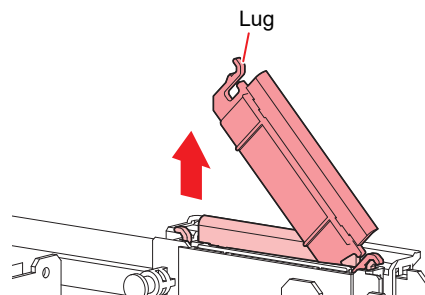

- 6 Clean the wiper slider.
 - Wipe off any ink and dust adhering using a cleaning stick moistened with maintenance liquid. Wipe off the maintenance liquid. Make sure none remains.

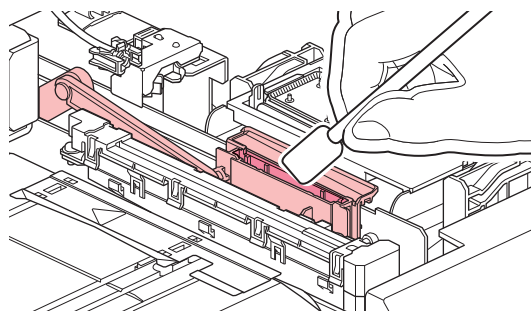

7 Mount a new wiper.

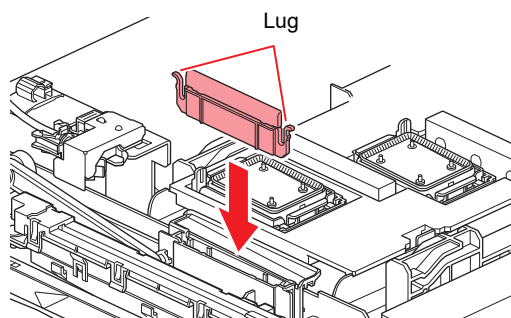

8 Once replacement is complete, close the cover, then press the [ENTER] key.

- The wiper usage count is reset.

Wiper Cleaner Replacement

Replace with a new wiper cleaner once a year.

- 1 On the LOCAL mode screen, select [MENU] > [Maintenance], then press the [ENTER] key.
 - The Maintenance menu is displayed.
- 2 Select [Station] > [Carriage Out] > [Move To Platen Right End], then press the [ENTER] key.
 - The carriage moves over the platen.
- 3 Open the front cover.
- 4 Remove the fitting.
 - Pull out the fitting by holding the protrusion.
 - Take care not to lose the rubber seals.

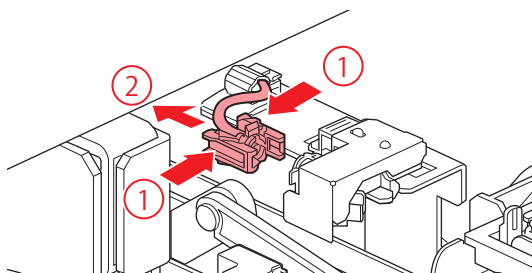

5 Remove the wiper cleaner.

- Pull it forward to detach it.

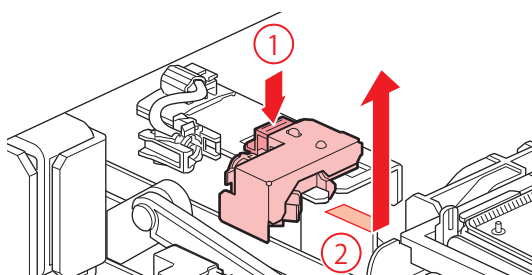

6 Mount a new wiper cleaner.

- Slide backward to attach.

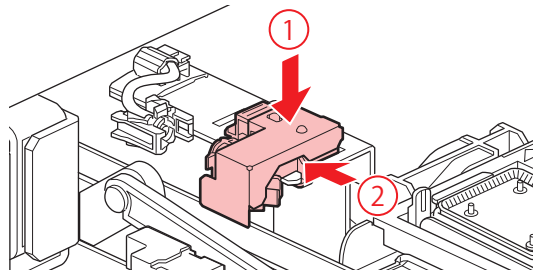

7 Attach the fitting.

- There is a risk of maintenance liquid leakage if not correctly mounted.

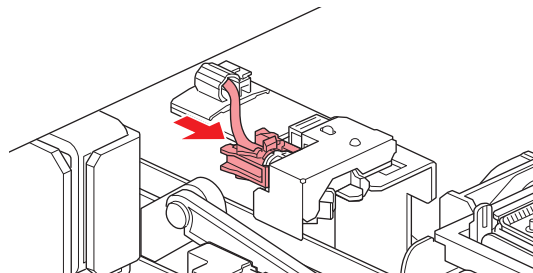

8 Once replacement is complete, close the cover, then press the [ENTER] key.

Cap Replacement

If print defects (e.g., nozzle clogging, deflection) remain unresolved even after cleaning, replace with a new cap.



- Be sure to replace the cap if you observe any scratches or other damage on the rim.



- 1 On the LOCAL mode screen, select [MENU] > [Maintenance], then press the [ENTER] key.
 - The Maintenance menu is displayed.
- 2 Select [Station] > [Carriage Out] > [Move To Platen Right End], then press the [ENTER] key.
 - The carriage moves over the platen.
- 3 Open the front cover.

4 Remove the cap.

- Squeeze the lugs on either side of the cap and pull off.

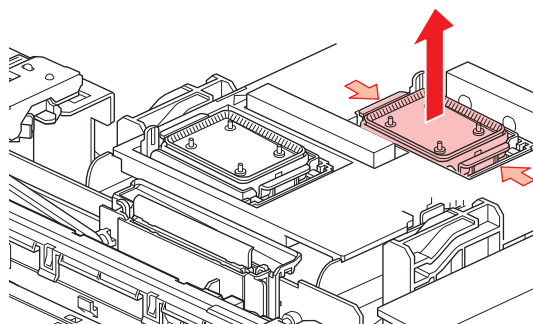
**5 Apply maintenance liquid.**

- Use a syringe to apply two or three drops of maintenance liquid to the hole at the front.

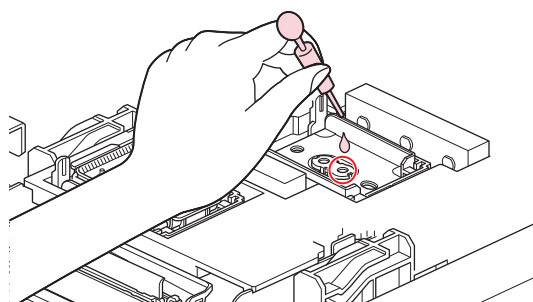
**6 Mount a new cap.**

- Position with the slot at the front and push in until it clicks.

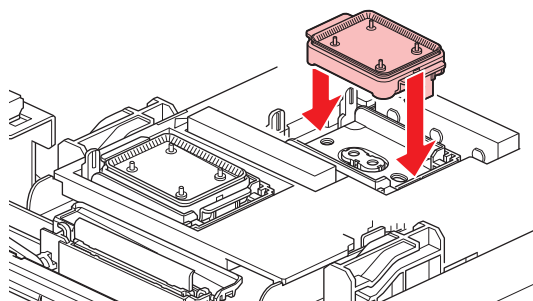
**7 Once replacement is complete, close the cover, then press the [ENTER] key.**

Cap Absorber Replacement

If the cap absorber is very dirty or if ink drips on to the media, replace with a new cap absorber.

- 1 On the LOCAL mode screen, select [MENU] > [Maintenance], then press the [ENTER] key.**
 - The Maintenance menu is displayed.
- 2 Select [Station] > [Carriage Out] > [Move To Platen Right End], then press the [ENTER] key.**
 - The carriage moves over the platen.
- 3 Turn off the power.**

- 9** Close the front cover, then turn on the power.
- Check to confirm that the carriage returns to the station.

Blowing Fan Filter Replacement

Replace the blowing fan filter if it is dirty.

- 1** Remove the fan filter cover.
- Push the fan filter cover claw outward, and pull the cover to the front.

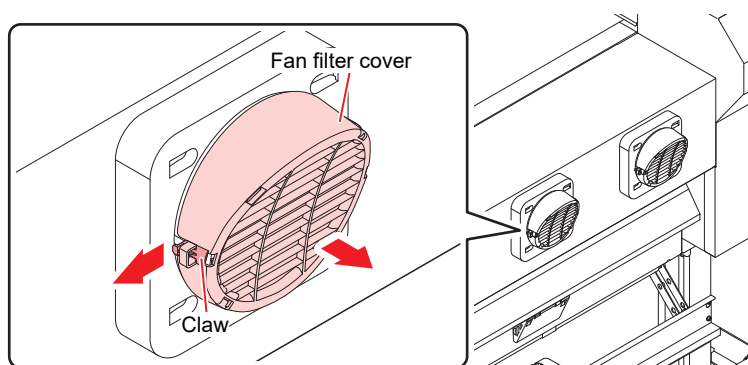

- 2** Remove the filter.

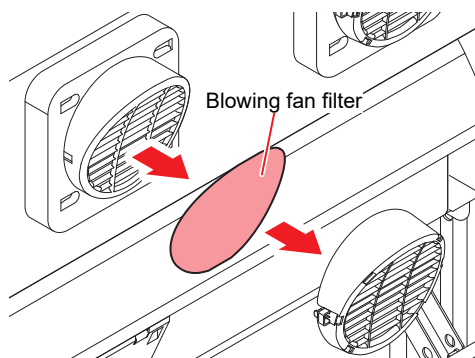

- 3** Mount a new filter and the fan filter cover.
- Push in the fan filter cover until the tab clicks.

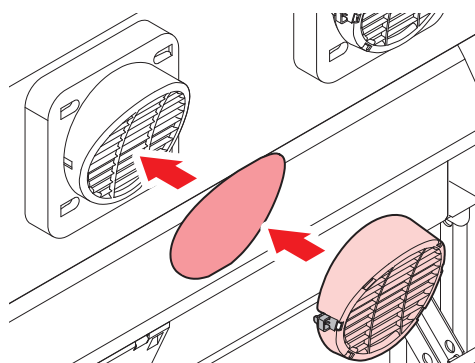

Pinch Roller Replacement

Replace worn or dirty pinch rollers with new ones.



- Turn off the main power and unplug the power cable before replacing the pinch rollers.

- 1 Open the front cover.
- 2 Raise the clamp lever.
- 3 Remove the O-ring retaining the pinch rollers.

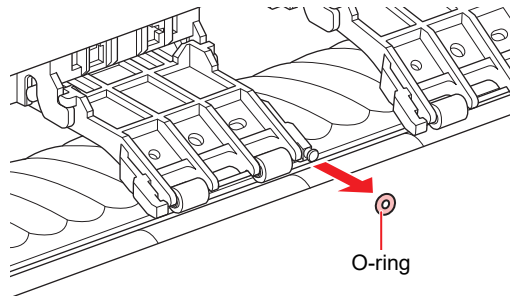

- The pinch rollers are small. Be careful to avoid dropping them into the product interior.

- 4 Remove the pinch rollers.

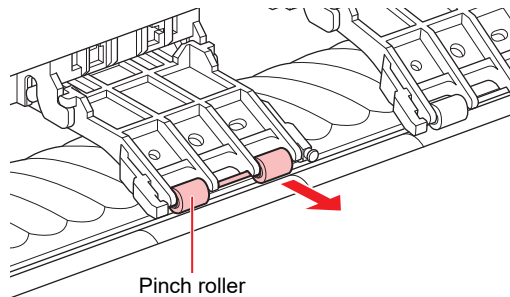

- 5 Mount new pinch rollers, and secure them using the O-ring.
- 6 Close the front cover.

Media Holder Replacement

If the media holder becomes deformed and touches the carriage or print head, replace with a new media holder.



- Turn off the main power supply and unplug the power cable before replacing the pinch rollers.

1 Open the maintenance covers.

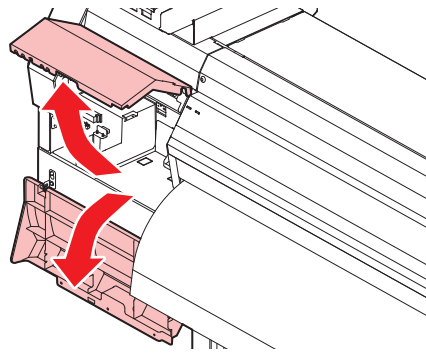

2 Remove the side screw, and detach the media holder stopper.

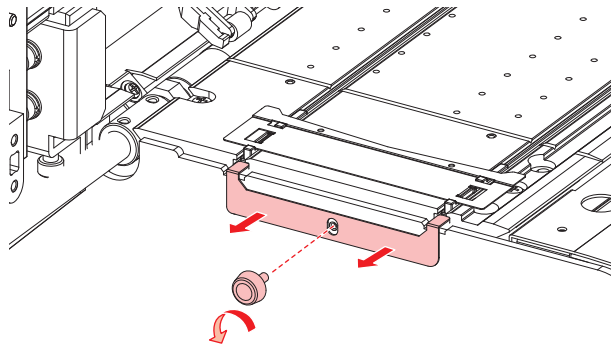

3 Remove the media holder.

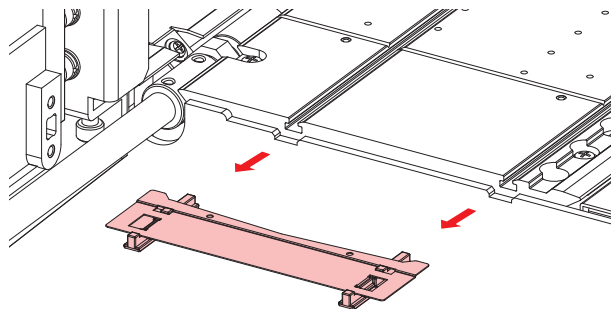

4 Remove the sliders from the media holder.

- Be careful to avoid misplacing the sliders.

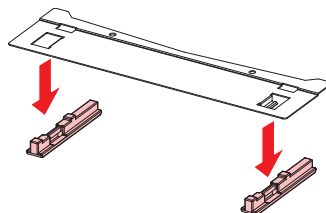

5 Mount the sliders on to the new media holder.

- Engage the holes in the sliders on to the lugs on the media holder.

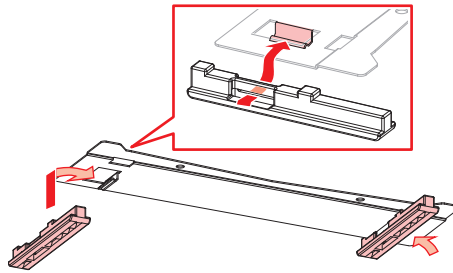

6 Mount the new media holder on to the platen.

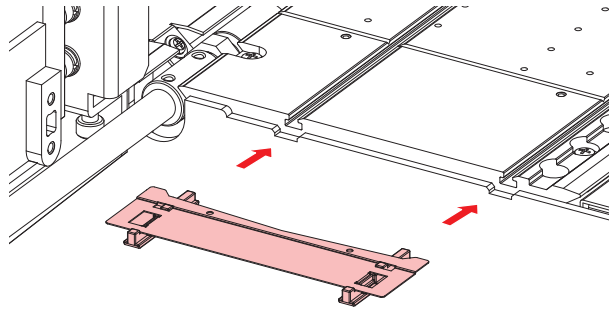

7 Secure the media holder stopper with the screw.

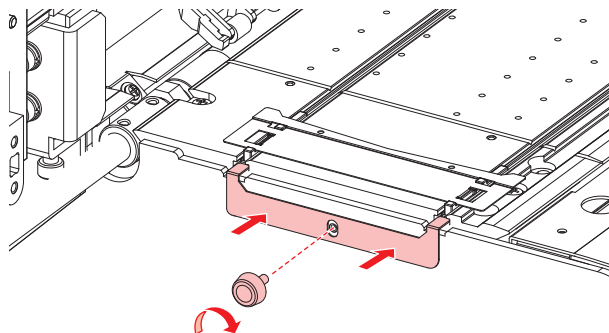

8 Close the maintenance covers.

Media Cutter Replacement

Replace cutters when blades are chipped or blunt.



- Avoid touching the cutter blade. Failure to do so may result in injury.



- Avoid storing this product in locations accessible to children.

1 On the LOCAL mode screen, select [MENU] > [Maintenance], then press the [ENTER] key.

- The Maintenance menu is displayed.

2 Select [Station] > [Carriage Out] > [Move To Platen Right End], then press the [ENTER] key.

- The carriage moves over the platen.

3 Open the front cover.



- The carriage can be moved by hand. Move the carriage slowly to a position allowing easy access for replacing the cutter.

4 Unscrew the screw, then open the carriage cover hatch.

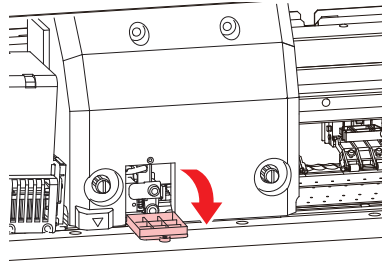

5 Replace the media cutter.

- (1) Unscrew the cutter screw.

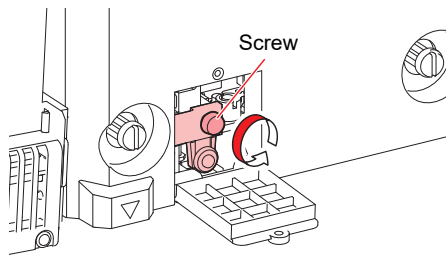

- (2) Remove the cutter.

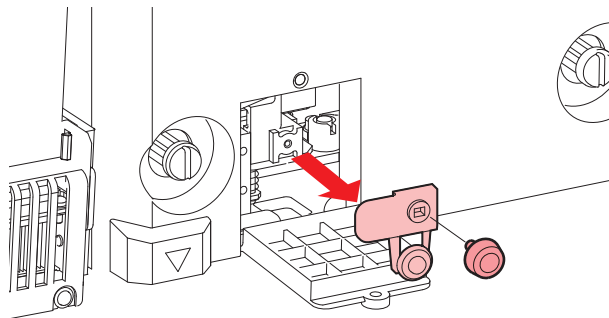

- (3) Mount a new cutter.

- (4) Tighten the screw to clamp the cutter.

6 Close the carriage cover hatch, then retighten the screw.

7 Once replacement is complete, close the cover, then press the [ENTER] key.



- When disposing of the product, contact an industrial waste disposal operator or dispose of the product in accordance with the local laws and regulations.

Waste Ink Tank Replacement

Ink used during head cleaning and other processes is collected in the waste ink tank at the lower right of the product.

This product keeps track of the waste ink level. A “Check Waste Ink Tank” message appears when the preset level is reached. Use this a guide for replacing the waste ink tank.



- For a 2-liter tank, the preset level is 80 % (1.6 liters).
- Continuing to use the product without disposing of the waste ink may result in waste ink overflowing from the waste ink tank. Visually check ink levels in the waste ink tank about once a week.



- Pay close attention to ventilation and be sure to wear safety glasses, gloves, and a mask when handling ink, maintenance liquid, waste ink, or other solutions used with this machine. Leaking ink may adhere to the skin or get into the eyes or mouth.



When “Check Waste Ink Tank” message appears

- 1 The “Check Waste Ink Tank” message appears on the display.
- 2 Check the waste ink levels in the waste ink tank.
 - If you note any discrepancies from actual levels, proceed to the next step.
 - If there is no discrepancy, replace (dispose of) the waste ink tank referring to  ["Replacing the Waste Ink Tank"\(P. 113\)](#).
- 3 On the LOCAL mode screen, select [MENU] > [Maintenance], then press the [ENTER] key.
 - The Maintenance menu is displayed.
- 4 Select [Waste Ink Tank], then press the [ENTER] key.
 - “Replace Wasteinktank Level: 80% (1.6L)” appears on the display.
- 5 Select [Adjust Waste Ink Volume], then press the [ENTER] key.
- 6 Press ▲▼ to adjust the level.
- 7 Press the [ENTER] key once adjustment is complete.

Replacing the Waste Ink Tank

- 1 On the LOCAL mode screen, select [MENU] > [Maintenance], then press the [ENTER] key.
 - The Maintenance menu is displayed.
- 2 Select [Waste Ink Tank], then press the [ENTER] key.
 - “Replace Wasteinktank Level: 80% (1.6L)” appears on the display.
- 3 Select [Reset Waste Ink Volume], then press the [ENTER] key.

4 Pull the waste ink tank stopper forward.

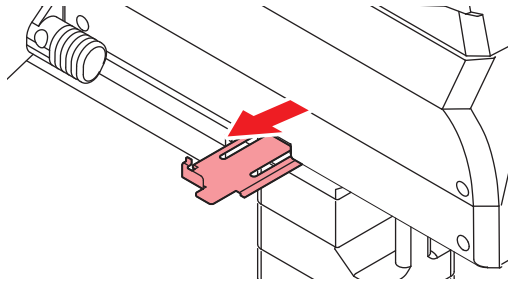

5 Hold the handle on the waste ink tank and slide out.

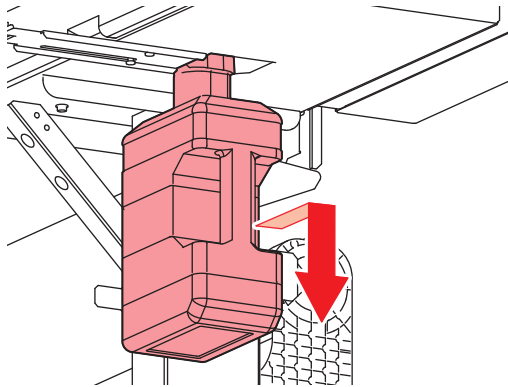

6 Attach the cap to the removed waste ink tank, and use tape to prevent leakage of waste ink.

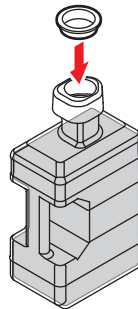

- When disposing of the product, contact an industrial waste disposal operator or dispose of the product in accordance with the local laws and regulations.

7 Mount a new waste ink tank.

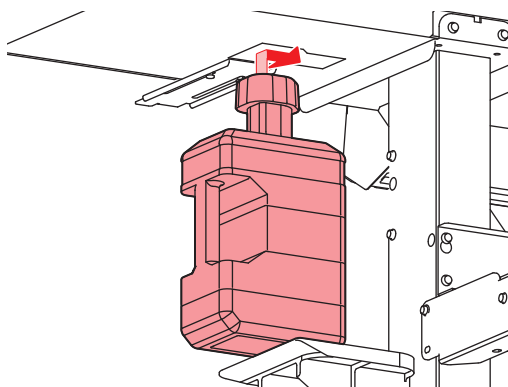

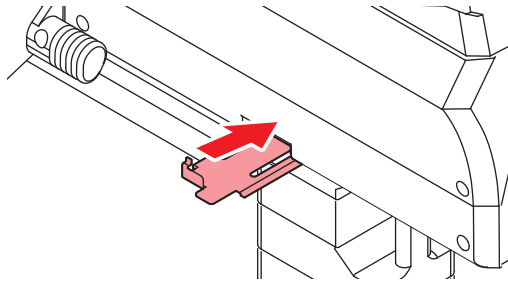
8 Close the waste ink tank stopper.**9** Press the [ENTER] key.

- The waste ink level will be reset.

Chapter 5 Troubleshooting



This chapter

Describes details such as corrective action when a fault is suspected and what action to take in response to messages appearing on the display.

Troubleshooting.....	118	The ink has leaked.....	121
The power does not turn on.	118	Problems indicated by messages.....	122
Printing is not possible.	118	Warning messages	122
The media jams or the media is dirty.	118	Ink error.....	124
Image defects occur.....	119	Error messages.....	125
The heater temperature does not rise to the specified value.	121	SYSTEM HALT	130



5.1 Troubleshooting

For information on troubleshooting, refer to this chapter. Refer to the following URL for frequently asked questions (FAQs) about this product and customer support videos.





<https://mimaki.com/support/>

If the recommended corrective action does not resolve the problem, contact your local dealer or our service office.

The power does not turn on.

Points to check	Corrective action
Is the machine connected to the power outlet by the power cable?	Insert the power plug securely into the power outlet.  "Connecting the Power Cable"(P. 30)
Are you using the power cable provided?	Use the power cable provided.
Is the main power supply turned on?	Turn on the main power.  "Turning On the Power"(P. 30)
Is the [END/POWER] key on the operating panel turned on?	Turn the power on.  "Turning On the Power"(P. 30)

Printing is not possible.

Points to check	Corrective action
Is a USB interface cable connected?	Connect the cable securely to the USB 2.0 port.  "Using a USB Cable"(P. 32)
Is a LAN cable connected?	Connect the cable securely to the LAN port.  "Using a LAN Cable"(P. 32)
Are you using a LAN cable approved by Mimaki?	Check the LAN cable type.  "Using a LAN Cable"(P. 32)
Is the status lamp on the operating panel illuminated or flashing red?	An error has occurred. Check the message on the display.  "Operating panel"(P. 26)

The media jams or the media is dirty.

Points to check	Corrective action
Are you using the recommended media?	Make sure you are using the recommended media. https://mimaki.com/supply/inkjet.html
Are you using curled media?	Do not use curled media or media with folded ends.
Is the media skewed?	Use the take-up unit to adjust the media or reload the media.  "Loading the Media"(P. 51)

Points to check	Corrective action
Does the media have ripples/surface irregularities or lift up?	<p>If you are using roll media, use a smooth section of the media for initial feeding. You can also improve this problem by attaching the NITOFLO[®] tape provided on the platen.</p>  <p>Attach the tape, taking care not to block the vacuum hole.</p> <p>For more information, refer to the description on transporting media on the platen. https://mimaki.com/download/inkjet.html</p>

Image defects occur.

Symptom	Corrective action
White streaks, blurriness, and dark streaks occur. (Carriage scan direction)	<ol style="list-style-type: none"> 1. Remove any paper scraps or other debris adhering to areas over which the head passes (e.g., media holders). ☞ "Media Holder Cleaning"(P. 98) ☞ "Platen Cleaning"(P. 99) 2. Perform the procedure described in ☞ "Head Cleaning"(P. 60). 3. Perform the procedure described in ☞ "Feed Correction"(P. 61). 4. Perform the procedure described in ☞ "Wiper Cleaning"(P. 92). 5. Perform the procedure described in ☞ "Cap Rubber Cleaning"(P. 93). 6. Perform the procedure described in ☞ "Carriage Underside Cleaning"(P. 95).
Text is double- or triple-printed in the media feed direction.	<ol style="list-style-type: none"> 1. Perform the procedure described in ☞ "Feed Correction"(P. 61).
Offsetting occurs during bidirectional printing.	<ol style="list-style-type: none"> 1. Perform the procedure described in ☞ "Correcting the Drop Position"(P. 63).
Ink droplets drip during printing.	<ol style="list-style-type: none"> 1. Perform the procedure described in ☞ "Wiper Cleaning"(P. 92). 2. Perform the procedure described in ☞ "Cap Rubber Cleaning"(P. 93). 3. Perform the procedure described in ☞ "Carriage Underside Cleaning"(P. 95). 4. Perform the procedure described in ☞ "Head Cleaning"(P. 60). 5. Set auto maintenance. ☞ "Maintenance menu"(P. 75)
Clear clogged nozzles.	<ol style="list-style-type: none"> 1. Perform the procedure described in ☞ "Head Cleaning"(P. 60). 2. Perform the procedure described in ☞ "Print Head Nozzle Washing"(P. 120). 3. Perform the procedure described in ☞ "Wiper Replacement"(P. 103). 4. Perform the procedure described in ☞ "Registering nozzle recovery"(P. 76).

Symptom	Corrective action
Vertically uneven color	<p>You can improve this problem by attaching the NITOFロン® tape provided on the platen.</p>  <p>Attach the tape, taking care not to block the vacuum hole.</p> <p>For more information, refer to the description on transporting media on the platen. https://mimaki.com/download/inkjet.html</p>

Print Head Nozzle Washing

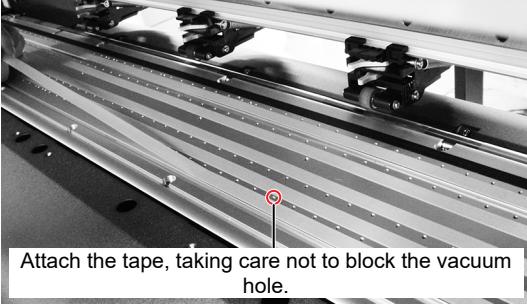
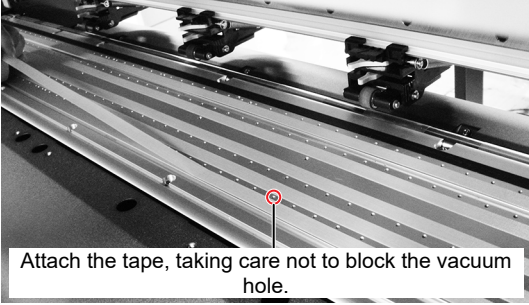
If printing defects (e.g., nozzle clogging or deflection) remain unresolved even after head cleaning (👉 "Head Cleaning"(P. 60)), apply nozzle washing to the print head.

- 1** On the LOCAL mode screen, select [MENU] > [Maintenance], then press the [ENTER] key.
 - The Maintenance menu is displayed.
- 2** Select [Station] > [Nozzle Wash], then press the [ENTER] key.
 - The carriage moves over the platen.
- 3** Open the front cover.
- 4** Clean the wiper and bracket.
 - 👉 "Wiper Cleaning"(P. 92)
- 5** Press the [ENTER] key once cleaning is complete.
 - "Cap Cleaning Completed (Next)[ENT]" appears on the display.
- 6** Clean the cap rubber.
 - 👉 "Cap Rubber Cleaning"(P. 93)
- 7** Once cleaning is complete, close the cover, then press the [ENTER] key.
 - The cap is filled with maintenance liquid.



- Close the front cover. The cap cannot be filled with maintenance liquid unless the front cover is closed. This is also true if the maintenance liquid cartridge is empty.

- 8** Open the front cover.
 - Check to confirm that the cap is filled with maintenance liquid.



- If not, use a syringe to draw up some maintenance liquid and fill until it almost overflows from the cap.

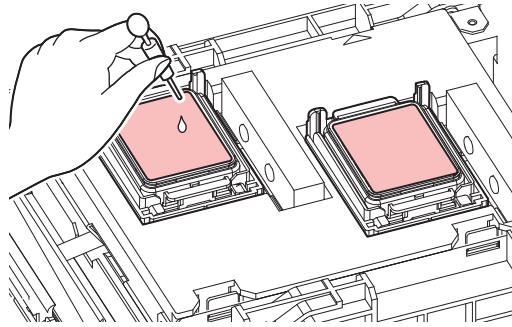

9 Close the front cover.

10 Set the exposure time, then press the [ENTER] key.

- Print nozzle washing starts. The elapsed time is displayed on the display.
- Cleaning is performed automatically once print nozzle washing has ended.



- If print defects (e.g., nozzle clogging, deflection) remain unresolved even after washing the nozzles several times, contact your local dealer or our service office.

The heater temperature does not rise to the specified value.

This may indicate a problem with the setting.

Points to check	Corrective action
Is the 100V/200V selector switch set correctly?	Set the selector switch according to the power supply voltage.
Is the heater temperature set?	Set the heater temperature. "Setting the Heater Temperature"(P. 57) "Setup Menu"(P. 72)

The ink has leaked.



- If an ink leak occurs, turn off the main power immediately and unplug the power cable. Contact your local dealer or our service office.





5.2 Problems indicated by messages

If a problem occurs, the buzzer will sound, and a message will appear on the display.

You can also use local guidance when checking.  ["Displaying Machine Information \(Local Guidance\)"\(P. 29\)](#)

Take appropriate measures based on the message. If a message is displayed again even after you take the recommended corrective action, contact your local dealer or our service office.

Warning messages

Message	Cause	Corrective action
MOTOR POWER OFF	<ul style="list-style-type: none"> The motor stops due to some action causing initialization—for example, opening the cover. 	<ul style="list-style-type: none"> Wait until the initialization operation is complete.
Replace NCU Ink Pad	<ul style="list-style-type: none"> The ink absorber needs to be replaced. 	<ul style="list-style-type: none"> The NCU ink absorber must be replaced. Contact your local distributor, our sales office, or service center.
REPLACE NCU	<ul style="list-style-type: none"> A problem was detected with the nozzle clogging assessment. 	<ul style="list-style-type: none"> The NCU must be replaced. Contact your local distributor, our sales office, or service center.
NCU Sensor Lv Low	<ul style="list-style-type: none"> The sensor's sensitivity is impaired. 	<ul style="list-style-type: none"> Clean the NCU.  "NCU Cleaning"(P. 94)
NCU Sens Adj Err H	<ul style="list-style-type: none"> Sensor sensitivity adjustment failed. 	<ul style="list-style-type: none"> Replace the NCU if the error does not clear. Contact your local distributor, our sales office, or service center.
NCU Sens Adj Err L		
NCU CONNECT	<ul style="list-style-type: none"> A problem was detected with the NCU connection. 	<ul style="list-style-type: none"> Turn off the power on the machine and turn it on after a while.  "Turning Off the Power"(P. 31)
Ink Error	<ul style="list-style-type: none"> An ink error occurred. 	<ul style="list-style-type: none"> Check the ink error details.  "Ink error"(P. 124)
COVER OPEN	<ul style="list-style-type: none"> The cover is open. 	<ul style="list-style-type: none"> Close the cover.
Lower the clamp lever	<ul style="list-style-type: none"> The clamp lever is raised. 	<ul style="list-style-type: none"> Lower the clamp lever.  "Front"(P. 20)
Heater Temp Error The power was turned off	<ul style="list-style-type: none"> This appears when the machine is started immediately after "ERROR710 Heater Temp Error" occurred. 	<ul style="list-style-type: none"> If displaying again, contact your local distributor, our sales office, or service center.
Data Remain	<ul style="list-style-type: none"> Print (RIP) data was received. 	<ul style="list-style-type: none"> Switch to REMOTE mode and start printing or clear the data and abort printing.
Temporary Suspension	<ul style="list-style-type: none"> Printing has been paused. 	<ul style="list-style-type: none"> Switch to REMOTE mode and resume printing or clear the data and abort printing.
Printing not possible/cartridge	<ul style="list-style-type: none"> An unusable ink IC chip is used. 	<ul style="list-style-type: none"> Replace with a new ink cartridge.
NO MEDIA	<ul style="list-style-type: none"> No media is loaded, or the sensors are faulty. 	<ul style="list-style-type: none"> Load the media.  "Loading the Media"(P. 51)

Message	Cause	Corrective action
		<ul style="list-style-type: none"> Clean the media sensor. "Media Sensor Cleaning"(P. 98)
Please load media.	<ul style="list-style-type: none"> No media is loaded, or the sensors are faulty. 	<ul style="list-style-type: none"> Load the media. "Loading the Media"(P. 51)
No media detected	<ul style="list-style-type: none"> The media width has not been detected. 	<ul style="list-style-type: none"> Detect the media width. "Loading the Media"(P. 51)
Replace Wiper	<ul style="list-style-type: none"> The wiping count exceeded the preset value. 	<ul style="list-style-type: none"> Replace the wiper, then reset the count. "Wiper Replacement"(P. 103)
Wiper Move Failure	<ul style="list-style-type: none"> The wiper is not operating correctly. 	<ol style="list-style-type: none"> Clean the wiper and around the wiper. "Wiper Cleaning"(P. 92) Turn off the power on the machine and turn it on after a while. "Turning Off the Power"(P. 31)
Replace Waste ink tank	<ul style="list-style-type: none"> The waste ink tank count exceeded the preset value (90%). 	<p>Automatic maintenance is not possible while the covers are open. Perform the following steps:</p> <ol style="list-style-type: none"> Check the waste ink levels in the waste ink tank. "When "Check Waste Ink Tank" message appears"(P. 113) Replace the waste ink tank, then reset the waste ink level. "Replacing the Waste Ink Tank"(P. 113)
Check Waste Ink Tank	<ul style="list-style-type: none"> The waste ink tank count exceeded the preset value (80%). 	<ol style="list-style-type: none"> Check the waste ink levels in the waste ink tank. "When "Check Waste Ink Tank" message appears"(P. 113) Replace the waste ink tank, then reset the waste ink level. "Replacing the Waste Ink Tank"(P. 113)
No washing liquid cartridge	<ul style="list-style-type: none"> No maintenance liquid cartridge is loaded. 	<ul style="list-style-type: none"> Load the maintenance liquid cartridge.
Replace the washing liquid cartridge	<ul style="list-style-type: none"> The maintenance liquid has run out. 	<ul style="list-style-type: none"> Replace with a new maintenance liquid cartridge.
Washing liquid end	<ul style="list-style-type: none"> The maintenance liquid has run out. 	<ul style="list-style-type: none"> Replace with a new maintenance liquid cartridge.
High ambient temp. ** ° C	<ul style="list-style-type: none"> Ambient temperatures are too high. 	<ul style="list-style-type: none"> Adjust ambient temperatures to temperatures within the specified range. Optimum print quality may not be possible unless ambient conditions are within the specified range. "Installation Precautions"(P. 14)
Low ambient temp. ** ° C	<ul style="list-style-type: none"> Ambient temperatures are too low. 	
Auto-correction failed	<ul style="list-style-type: none"> White media is not used. The media is dirty. The media lifts up. There is dirt around the sensor. 	<ul style="list-style-type: none"> Load white and clean media. Load media so it does not lift up. Clean the area around the sensor. "Automatic Correction Sensor (DAS) Cleaning"(P. 96) If automatic correction fails repeatedly, correct the position manually. [MENU] > [Setup] > [Feed Comp.] or [Drop.PosCorrect]





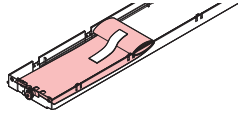





Ink error

Message	Cause	Corrective action
INK END	<ul style="list-style-type: none"> The ink has run out. 	<ul style="list-style-type: none"> Replace with new ink. "When Ink End is Displayed"(P. 39) If you use UISS, you may perform cleaning.
INK NEAR END	<ul style="list-style-type: none"> Ink levels are low. 	<ul style="list-style-type: none"> The ink will run out soon. Have new ink ready. "When Ink Level Low or Ink Near End is displayed"(P. 38)
No cartridge	<ul style="list-style-type: none"> The ink cartridge is not inserted into the ink supply unit. 	<ol style="list-style-type: none"> Check to confirm that the ink cartridge was inserted correctly. Check to confirm that the ink IC chip was inserted correctly in the ink cartridge. "Replacing Ink"(P. 40) Turn off the power on the machine and turn it on after a while. "Turning Off the Power"(P. 31)
Wrong Ink IC	<ul style="list-style-type: none"> An error occurred with the information on the ink IC chip. 	<ol style="list-style-type: none"> Check to confirm that the ink cartridge was inserted correctly. Turn off the power on the machine and turn it on after a while. "Turning Off the Power"(P. 31) Replace with a new ink cartridge. "Replacing Ink"(P. 40)
Ink Color	<ul style="list-style-type: none"> The ink color filled differs from the ink color registered on the ink IC chip. 	<ul style="list-style-type: none"> Insert an ink cartridge for the correct ink color. "Replacing Ink"(P. 40)
Ink level 0	<ul style="list-style-type: none"> The ink level is now 0 ml. 	<ul style="list-style-type: none"> Replace with new ink. "Replacing Ink"(P. 40)
Ink Type	<ul style="list-style-type: none"> The ink type filled differs from the ink type registered on the ink IC chip. 	<ul style="list-style-type: none"> Insert an ink cartridge for the correct ink type. "Replacing Ink"(P. 40)
Expiration	<ul style="list-style-type: none"> The ink has expired. 	<ul style="list-style-type: none"> Replace with new ink or use up as quickly as possible. Printing is possible. "Replacing Ink"(P. 40)
Expiration:1MONTH	<ul style="list-style-type: none"> The ink is one month past its expiration date and cannot be used. 	
Expiration:2MONTH	<ul style="list-style-type: none"> The ink is two months past its expiration date and cannot be used. 	
Ink cartridge check ver.4.2 or later	<ul style="list-style-type: none"> The ink remaining in the 600 ml cartridge is below 250 ml. 	<ol style="list-style-type: none"> Remove the ink cartridge, and measure the weight. "Correcting the Ink Cartridge Case Weight"(P. 83)
Ink level end (1 First time) ver.4.2 or later	<ul style="list-style-type: none"> After the Ink cartridge check was displayed, 130ml of ink was consumed. <ul style="list-style-type: none"> It will not appear if you have performed ink pack folding and cartridge weight correction 	<ol style="list-style-type: none"> Enter the measured weight into the machine. "Correcting the Ink Cartridge Case Weight"(P. 83)

Message	Cause	Corrective action
	"Correcting the Ink Cartridge Case Weight"(P. 83)) after the Ink cartridge check appears.	3. Open the lid on the ink cartridge and fold the ink pack.  Set the ink pack as shown and enter the cartridge weight.
Ink level low	<ul style="list-style-type: none"> The ink remaining in the 600 ml cartridge is below 60 ml. 	1. Remove the ink cartridge, and measure the weight. (☞) "Correcting the Ink Cartridge Case Weight"(P. 83)
INK NEAR-END	<ul style="list-style-type: none"> The amount of ink remaining after cartridge weight compensation (☞) "Correcting the Ink Cartridge Case Weight"(P. 83)) is below 60ml. 	2. Enter the measured weight into the machine. (☞) "Correcting the Ink Cartridge Case Weight"(P. 83)
Ink level end	<ul style="list-style-type: none"> The ink remaining in the 600 ml cartridge is below 30ml. 	1. Remove the ink cartridge, and measure the weight. (☞) "Correcting the Ink Cartridge Case Weight"(P. 83) 2. Enter the measured weight into the machine. (☞) "Correcting the Ink Cartridge Case Weight"(P. 83)
Replace Inkpack (Ink End)	<ul style="list-style-type: none"> The amount of ink remaining after cartridge weight compensation (☞) "Correcting the Ink Cartridge Case Weight"(P. 83)) is below 30ml. 	1. Replace Ink pack. (☞) "Replacing Ink"(P. 40)
Cartridge abnormality	<ul style="list-style-type: none"> The ink usage amount exceeded the preset value. 	<ul style="list-style-type: none"> Replace with new ink. (☞) "Replacing Ink"(P. 40) Check to confirm the nozzle is not clogged.

Error messages

Error number	Message	Cause	Corrective action
04	PARAM ROM	<ul style="list-style-type: none"> A problem was detected with the main PCB. 	<ul style="list-style-type: none"> Turn off the power on the machine and turn it on after a while. (☞) "Turning Off the Power"(P. 31)
108	HD THERMIS [1234]	<ul style="list-style-type: none"> A problem was detected with print head temperature control. 	<ul style="list-style-type: none"> Turn off the power on the machine and turn it on after a while. (☞) "Turning Off the Power"(P. 31)
108	HD CONNECT [1234]	<ul style="list-style-type: none"> A problem was detected with the print head connection. 	
122	CHECK:SDRAM	<ul style="list-style-type: none"> A problem was detected with the SDRAM. 	<ul style="list-style-type: none"> Turn off the power on the machine and turn it on after a while. (☞) "Turning Off the Power"(P. 31)

Error number	Message	Cause	Corrective action
128	HDC FIFO OVER	<ul style="list-style-type: none"> A problem was detected with the print head control PCB. 	
128	HDC FIFO UNDER		
129	Battery Exchange	<ul style="list-style-type: none"> The internal clock battery is spent and must be replaced. 	<ul style="list-style-type: none"> Contact your local distributor, our sales office, or service center.
12a	HDC SPEED	<ul style="list-style-type: none"> A problem was detected with the print head control. 	<ul style="list-style-type: none"> Turn off the power on the machine and turn it on after a while.  "Turning Off the Power"(P. 31)
130	HD DATA SEQ		
148	E-LOG SEQ	<ul style="list-style-type: none"> A log control abnormality was detected. 	<ul style="list-style-type: none"> Turn off the power on the machine and turn it on after a while.  "Turning Off the Power"(P. 31)
151	Main PCB V1R2	<ul style="list-style-type: none"> A problem was detected with the main PCB power supply circuit. 	<ul style="list-style-type: none"> Turn off the power on the machine and turn it on after a while.  "Turning Off the Power"(P. 31)
152	Main PCB V2R5		
153	Main PCB V3R3		
154	Main PCB V05		
157	Main PCB VTT		
158	Main PCB V36-2		
15f	HEAD DRIVE HOT	<ul style="list-style-type: none"> The COM drive has overheated. 	<ul style="list-style-type: none"> Turn off the power on the machine and turn it on after a while.  "Turning Off the Power"(P. 31)
16e	Main PCB V3R3B	<ul style="list-style-type: none"> A problem was detected with the main PCB power supply circuit. 	
171	NEW HEAD CONNECT	<ul style="list-style-type: none"> A new print head connection was detected. 	
18a	Main PCB V_CORE	<ul style="list-style-type: none"> A problem was detected with the main PCB power supply. 	<ul style="list-style-type: none"> Turn off the power on the machine and turn it on after a while.  "Turning Off the Power"(P. 31)
18b	Main PCB V1R5B		
18c	Main PCB V12		
18e	FLS NOT COMP	<ul style="list-style-type: none"> A problem was detected with the print head control. 	<ul style="list-style-type: none"> Turn off the power on the machine and turn it on after a while.  "Turning Off the Power"(P. 31)
18f	OFSET START		
18f	OFSET END		
1e6	PRAM Size Shortage	<ul style="list-style-type: none"> Insufficient memory 	<ul style="list-style-type: none"> Turn off the power on the machine and turn it on after a while.  "Turning Off the Power"(P. 31)
201	Command Error	<ul style="list-style-type: none"> Data other than print (RIP) data was received, or a problem was detected with the print (RIP) data received. 	<ol style="list-style-type: none"> Clear the data and resend. Check the USB cable connection.  "Using a USB Cable"(P. 32) Use a compliant USB cable.  "USB Connection Precautions"(P. 32) Turn off the power on the machine and turn it on after a while.  "Turning Off the Power"(P. 31)
202	Parameter Error	<ul style="list-style-type: none"> A problem was detected with the print (RIP) data received. 	
206	Printing Mode	<ul style="list-style-type: none"> Print (RIP) data was received with print parameters that do not allow printing. 	<ul style="list-style-type: none"> Change the output parameters and profile using RIP software.

Error number	Message	Cause	Corrective action
20A	Driver version	<ul style="list-style-type: none"> Printing is not possible because the Mimaki driver version is old. 	<ul style="list-style-type: none"> Install the latest Mimaki driver available from: https://mimaki.com/download/inkjet.html
304	USB INIT ERR	<ul style="list-style-type: none"> A problem was detected with the USB cable connection. 	<ol style="list-style-type: none"> Check the USB cable connection. "Using a USB Cable"(P. 32) Use a compliant USB cable. "USB Connection Precautions"(P. 32) Turn off the power on the machine and turn it on after a while. "Turning Off the Power"(P. 31)
305	USB TIME OUT		
307	MCFD File IF Error	<ul style="list-style-type: none"> A problem was detected while accessing print parameter data. 	<ul style="list-style-type: none"> Turn off the power on the machine and turn it on after a while. "Turning Off the Power"(P. 31)
401	Motor X	<ul style="list-style-type: none"> The X motor was overloaded. 	<ol style="list-style-type: none"> Check to confirm the media is loaded correctly. "Loading the Media"(P. 51) Open the front cover and check for anything that may obstruct carriage movement. Turn off the power on the machine and turn it on after a while. "Turning Off the Power"(P. 31)
402	Motor Y	<ul style="list-style-type: none"> The Y motor was overloaded. 	
403	X Current	<ul style="list-style-type: none"> An overcurrent was detected in the X motor. 	
404	Y Current	<ul style="list-style-type: none"> An overcurrent was detected in the Y motor. 	
406	Wiper Move Failure	<ul style="list-style-type: none"> Unable to detect the wiper origin. 	<ol style="list-style-type: none"> Clean the wiper and around the wiper. "Wiper Cleaning"(P. 92) Turn off the power on the machine and turn it on after a while. "Turning Off the Power"(P. 31)
44f	Take-up Roll Sns Err	<ul style="list-style-type: none"> A problem was detected with the take-up unit sensor spindle. 	<ol style="list-style-type: none"> Check to confirm the [Machine Setup] > [Feeding/Take-up] > [Take-up Unit] setting is "ON". Check to confirm the media is loaded correctly. "Loading the Roll Media"(P. 53) Check to confirm the take-up unit switch functions properly. "Take-up unit"(P. 51)
48a	Detect winding failure	<ul style="list-style-type: none"> The take-up unit is unable to take up media. 	<ul style="list-style-type: none"> Check to confirm the media is loaded correctly. "Loading the Roll Media"(P. 53)
504	CLAMP UP	<ul style="list-style-type: none"> The clamp lever is lifted. 	<ul style="list-style-type: none"> Lower the clamp lever.
505	MEDIA JAM	<ul style="list-style-type: none"> The media jam sensor was triggered. 	<ol style="list-style-type: none"> Remove the media in contact with the carriage and reload with fresh media. "Loading the Media"(P. 51) Open the front cover and check for anything that may obstruct carriage movement.
509	HDC POSCNT	<ul style="list-style-type: none"> A problem was detected with position control. 	<ul style="list-style-type: none"> Turn off the power on the machine and turn it on after a while. "Turning Off the Power"(P. 31)
50a	Y ORIGIN	<ul style="list-style-type: none"> A problem was detected with Y origin detection (initialization). 	

Error number	Message	Cause	Corrective action
50c	Media Width Sensor	<ul style="list-style-type: none"> A problem was detected with media width detection. 	<ol style="list-style-type: none"> Check the media loading position. "Loading the Media"(P. 51) Clean the media width sensor. "Media Sensor Cleaning"(P. 98)
50f	L-SCALE BLACK	<ul style="list-style-type: none"> A problem was detected with the linear scale. 	<ul style="list-style-type: none"> Turn off the power on the machine and turn it on after a while. "Turning Off the Power"(P. 31)
516	Media Set Position R	<ul style="list-style-type: none"> The media was loaded outside the range of valid positions. 	<ol style="list-style-type: none"> Check the media loading position. "Loading the Media"(P. 51) Clean the media width sensor. "Media Sensor Cleaning"(P. 98)
528	Pump Motor Sensor	<ul style="list-style-type: none"> A problem was detected with the pump motor. 	<ul style="list-style-type: none"> Turn off the power on the machine and turn it on after a while. "Turning Off the Power"(P. 31)
549	LEnc. Count DIO	<ul style="list-style-type: none"> A problem was detected with the linear scale wiring to the DIO PCB. 	<ul style="list-style-type: none"> Turn off the power on the machine and turn it on after a while. "Turning Off the Power"(P. 31)
602	Ink end	<ul style="list-style-type: none"> The ink has run out. 	<ul style="list-style-type: none"> Replace with new ink. When Ink End is Displayed
608	Wrong Ink IC	<ul style="list-style-type: none"> An error occurred with the information on the ink IC chip. 	<ol style="list-style-type: none"> Check to confirm that the ink cartridge was inserted correctly. Turn off the power on the machine and turn it on after a while. "Turning Off the Power"(P. 31) Replace with a new ink cartridge. "Replacing Ink"(P. 40)
627	Cartridge load	<ul style="list-style-type: none"> The ink IC chip could not be read for a certain period of time. 	<ol style="list-style-type: none"> Check to confirm that the ink cartridge was inserted correctly. Turn off the power on the machine and turn it on after a while. "Turning Off the Power"(P. 31)
628	Cartridge abnormality	<ul style="list-style-type: none"> The ink usage amount exceeded the preset value. 	<ul style="list-style-type: none"> Replace with new ink. "Replacing Ink"(P. 40) Check to confirm the nozzle is not clogged.
63c	Ink level 0	<ul style="list-style-type: none"> The ink level is now 0 ml. 	<ul style="list-style-type: none"> Replace with new ink. "Replacing Ink"(P. 40)
64C	NCU error	<ul style="list-style-type: none"> The function cannot be executed due to an error. 	<ul style="list-style-type: none"> Turn off the power on the machine and turn it on after a while. "Turning Off the Power"(P. 31)
650	NCU CONNECT	<ul style="list-style-type: none"> A problem was detected with the NCU connection. 	
651	REPLACE NCU	<ul style="list-style-type: none"> A problem was detected with the nozzle clogging assessment. 	<ul style="list-style-type: none"> The NCU must be replaced. Contact your local distributor, our sales office, or service center.
652	NCU detection error (HW)	<ul style="list-style-type: none"> A problem was detected with the nozzle clogging assessment. Printing position adjustment failed. 	<ul style="list-style-type: none"> Clean the NCU. "NCU Cleaning"(P. 94)
653	NCU NZK CHK (Mark)		
654	NCU CENTER POS		
655	NCU FLUSH POS		

Error number	Message	Cause	Corrective action
656	NCU SN Adjst error	<ul style="list-style-type: none"> Sensor sensitivity adjustment failed. 	
657	Replace NCU Ink Pad	<ul style="list-style-type: none"> The NCU ink absorber is full. 	<ul style="list-style-type: none"> The NCU ink absorber must be replaced. Contact your local distributor, our sales office, or service center.
658	NCU Sensor Lv Low	<ul style="list-style-type: none"> The sensor's sensitivity is impaired. 	<ul style="list-style-type: none"> Clean the NCU. "NCU Cleaning"(P. 94) Replace the NCU if the error does not clear. Contact your local distributor, our sales office, or service center.
65b	NCU Sens Adj Err H	<ul style="list-style-type: none"> Sensor sensitivity adjustment failed. 	
65c	NCU Sens Adj Err L		
702	Thermistor Connect	<ul style="list-style-type: none"> A problem was detected with the thermistor connection. 	<ul style="list-style-type: none"> Turn off the power on the machine and turn it on after a while. "Turning Off the Power"(P. 31)
710	Heater Temp Error	<ul style="list-style-type: none"> A problem was detected with the heater temperature. 	<ul style="list-style-type: none"> This error will be automatically resolved. If not, Turn off the power on the machine and turn it on after a while. "Turning Off the Power"(P. 31)
901	INVALID OPERATION	<ul style="list-style-type: none"> The function cannot be executed due to an error. 	<ul style="list-style-type: none"> Check the error details.
902	Data Remain	<ul style="list-style-type: none"> Print (RIP) data was received. 	<ul style="list-style-type: none"> Switch to REMOTE mode and start printing or clear the data and abort printing.
90d	No Head Select	<ul style="list-style-type: none"> A problem was detected with the print head. 	<ul style="list-style-type: none"> Turn off the power on the machine and turn it on after a while. "Turning Off the Power"(P. 31)
90f	Print Area Short	<ul style="list-style-type: none"> The media is too small for the print. 	<ul style="list-style-type: none"> Replace with wider or longer media. If the printable area is reduced due to a shift in the origin, move the origin to increase the size of the printable area.
b1b	BaseIO PCB Vpow-s	<ul style="list-style-type: none"> A problem was detected with the Base IO PCB power supply. 	<ul style="list-style-type: none"> Turn off the power on the machine and turn it on after a while. "Turning Off the Power"(P. 31)
b1c	BaseIO PCB V24		
b1d	BaseIO PCB V24-A		
b21	SLIDER1 PCB V3R3	<ul style="list-style-type: none"> A problem was detected with the slider PCB power supply. 	<ul style="list-style-type: none"> Turn off the power on the machine and turn it on after a while. "Turning Off the Power"(P. 31)
b22	SLIDER1 PCB V2R5		
b23	SLIDER1 PCB V1R8		
b24	SLIDER1 PCB V1R2		
d09	HD MEMORY [1234]	<ul style="list-style-type: none"> A problem was detected with head internal memory. 	<ul style="list-style-type: none"> Turn off the power on the machine and turn it on after a while. "Turning Off the Power"(P. 31)

SYSTEM HALT

Error number	Message	Corrective action
406	WIPER ORG	<ol style="list-style-type: none"> Clean the wiper and around the wiper. ☞ "Wiper Cleaning"(P. 92) Turn off the power on the machine and turn it on after a while. ☞ "Turning Off the Power"(P. 31)
1c3	PCB SLDR2H	<ol style="list-style-type: none"> Turn off the power on the machine and turn it on after a while. ☞ "Turning Off the Power"(P. 31)



- If any other SYSTEM HALT number is displayed, Turn off the power on the machine and turn it on after a while.☞ "Turning Off the Power"(P. 31)

Chapter 6 Appendix



This chapter

This chapter explains the specifications of this machine.

Specifications	132	Drying Fan Unit (OPT-J0351).....	136
About the Relay Box.....	135	LICENSE Library	137

6.1 Specifications

Item		Details
Print head	Type	Drop-on-demand piezoelectric print heads
	Specifications	Two staggered heads with 420 nozzles × 4 rows each
	Resolution	Y: 360 dpi, 720 dpi, 1,200 dpi X: 600 dpi, 900 dpi, 1,200 dpi
Ink set	4-color	C, M, Y, K (UISS functions on all)
	8-color	C, M, Y, K, Lc, Lm, Lk, Or
Media	Type	PVC sheet (not more than 0.25 mm in thickness, including laminating layer), tarpaulin, FF
	Maximum printing width ^{*1}	1,610 mm
	Maximum width	1,620 mm
	Minimum width	210 mm
	Thickness	Max. 1.0 mm
	Roll external diameter ^{*2}	Max. 250 mm (paper media), max. 210 mm (other media)
	Roll weight ^{*2, *3}	Max. 45 kg
	Core internal diameter ^{*4}	2 inches or 3 inches
	Printing face	Exterior/interior
	Roll end	Taped or loosely affixed to core
Print margins	Left/right	15.0 mm (default), minimum: Left/right 5 mm
	Top end	120 mm
	Bottom end	150 mm
Distance accuracy ^{*5}	Absolute accuracy	±0.3 mm or ±0.3 % of specified distance, whichever is greater
	Duplicability	±0.2 mm or ±0.1 % of specified distance, whichever is greater
Perpendicularity		±0.5 mm/1,000 mm
Media skew		Not more than 5 mm/10 m
Printing gap		Manual, two settings (2.0 mm, 2.5 mm)
Media cutting		Cutting precision (steps): Not more than 0.5 mm
Origin alignment		LED pointer
Ink supply		Ink cartridge
Maintenance liquid feed		Cartridge
Waste ink tank		Bottle type (2,000 ml)
Take-up unit		Selectable inside/outside winding
Media heater		PRE, PRINT, POST (Independent control)
NCU (Nozzle clogging detection)		Provided

Item		Details
UV unit		N/A
Interface	Data transfer function	USB 2.0 Hi-speed, Ethernet 1000BASE-T
	Email function	Ethernet 10BASE-T/100BASE-TX/1000BASE-T
Commands		MRL-V
Languages		English, Japanese, Chinese
Noise levels	At standby	Not more than 58 dB (FAST-A, 1 m on all sides)
	Continuous operation	Not more than 65 dB
	Non-continuous operation	Not more than 75 dB
Compliance with standards		VCCI Class A, FCC Class A, IEC 62368-1 ETL compliance, CE marking (EMC Directive, Low Voltage Directive, Machinery Directive), CB certified, RoHS, REACH, EnergyStar, EAC marking, RCM marking
Power supply specifications ^{*6}		Single-phase 100 to 120 V AC $\pm 10\%$ /12 A, single-phase 200 to 240 V AC $\pm 10\%$ /8 A, 50/60 Hz ± 1 Hz x2
Power consumption	Maximum ^{*7}	[Inlet1]: Not more than 1,000 W (100 V to 120 V AC), not more than 1,300 W (200 V to 240 V AC) [Inlet2]: Not more than 1,000 W (100 V to 120 V AC), not more than 1,300 W (200 V to 240 V AC)
	Minimum ^{*8}	[Inlet1]: Not more than 4.5 W [Inlet2]: ----
Installation environment ^{*9}	Permissible ambient temperature	20 °C to 30 °C
	Relative humidity	35 to 65 %RH (no condensation)
	Temperature range in which accuracy is guaranteed	20 °C to 25 °C
	Temperature gradient	Not more than ± 10 °C/h
	Dust	0.15 mg/m ³ (typical office)
	Maximum operating altitude	2,000 m
External dimensions ^{*10}	Width	2,775 mm (2,980 mm)
	Depth	700 mm (750 mm)
	Height	1,392 mm (1,050 mm)

Item	Details
Weight ^{*10}	166 kg (208 kg)

- *1. Setup menu margins set to the minimum (5 mm) on either side
- *2. External diameter and weight after winding media
- *3. Free of sagging due to weight
- *4. High-speed printing is possible only with 3-inch.
- *5. Excluding media size variation and fluctuations at initial loading
- *6. Excluding options
- *7. Varies depending on print mode
- *8. In sleep
- *9. Ink printing consistency will decrease in conditions outside this range.
- *10. The figures in parentheses indicate package dimensions.

6.2 About the Relay Box



- A fire may occur if another manufacturer's external drying heater is used. Be sure to connect to the machine via the specified optional compact relay box or the relay box 2.



- The JV100-160 allows only one relay box (OPT-J0370 or OPT-J0407) to be connected.



- The optional connection relay cable (OPT-J0512 drying fan connection kit) is required when using a relay box.

● Outline

The relay box switches the heater power on and off automatically linked to the machine operation.

- The heater power is shut off if printing stops to prevent heating while no operation is in progress.
- The relay box does not have the temperature control function of the external drying heater. Set the temperature on the external drying heater side.

● Specifications

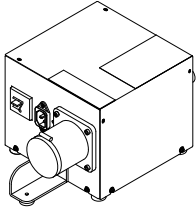
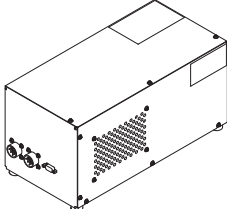
Compact relay box (OPT-J0370) 	Power supply specifications	Single-phase 100 to 120 V AC/12 A, single-phase 200 to 240 V AC/8 A, 50/60 Hz, single-circuit supply from main power supply
	Type	Electric heater using resistance heater, or lamp
Relay box 2 (OPT-J0407) 	Power supply specifications	Single-phase 100 V to 240 V AC/30 A, 50/60 Hz, single-circuit main power supply
	Type	Electric heater using resistance heater, or lamp

6.3 Drying Fan Unit (OPT-J0351)



- The optional connection relay cable (OPT-J0512 drying fan connection kit) is required when using the drying fan unit.

● Outline

The drying fan unit switches the drying fan on and off automatically in conjunction with machine operation.

- The flow rate can be adjusted.
- The optional exhaust fan unit (OPT-J0353) can be connected to the drying fan unit.

● Specifications

Power supply specifications	Installation environment	
	Permissible ambient temperature	Relative humidity
Single phase 100 V to 240 V AC/1.4A, 50/60 Hz	20 °C to 30 °C	35 to 65 %RH (no condensation)



- For more information, refer to the operating manual included with the optional drying fan unit.

6.4 LICENSE Library

Mimaki printer Firmware

Copyright ©2020 MIMAKI ENGINEERING CO.,LTD. All rights reserved.

This product contain open source software listed in the tables below.

Component	License
StarterWare for ARM® based TI Sitara Processors	BSD-TI

The following license terms and conditions shall apply to the open source software listed in the table above:

BSD-TI

Copyright (C) 2010 Texas Instruments Incorporated - <http://www.ti.com/>

Redistribution and use in source and binary forms, with or without modification, are permitted provided that the following conditions are met:

1. Redistributions of source code must retain the above copyright notice, this list of conditions and the following disclaimer.
2. Redistributions in binary form must reproduce the above copyright notice, this list of conditions and the following disclaimer in the documentation and/or other materials provided with the distribution.
3. Neither the name of Texas Instruments Incorporated nor the names of its contributors may be used to endorse or promote products derived from this software without specific prior written permission.

THIS SOFTWARE IS PROVIDED BY THE COPYRIGHT HOLDERS AND CONTRIBUTORS "AS IS" AND ANY EXPRESS OR IMPLIED WARRANTIES, INCLUDING, BUT NOT LIMITED TO, THE IMPLIED WARRANTIES OF MERCHANTABILITY AND FITNESS FOR A PARTICULAR PURPOSE ARE DISCLAIMED. IN NO EVENT SHALL THE COPYRIGHT OWNER OR CONTRIBUTORS BE LIABLE FOR ANY DIRECT, INDIRECT, INCIDENTAL, SPECIAL, EXEMPLARY, OR CONSEQUENTIAL DAMAGES (INCLUDING, BUT NOT LIMITED TO, PROCUREMENT OF SUBSTITUTE GOODS OR SERVICES; LOSS OF USE, DATA, OR PROFITS; OR BUSINESS INTERRUPTION) HOWEVER CAUSED AND ON ANY THEORY OF LIABILITY, WHETHER IN CONTRACT, STRICT LIABILITY, OR TORT (INCLUDING NEGLIGENCE OR OTHERWISE) ARISING IN ANY WAY OUT OF THE USE OF THIS SOFTWARE, EVEN IF ADVISED OF THE POSSIBILITY OF SUCH DAMAGE.

Index

Numerical	
600cc cartridge	80
A	
AC inlet	21
Adjust Waste Ink Volume	113
Auto Cleaning	73
Auto Correct	96, 123
Auto Correct	72
Auto Maint.	75
Auto Nozzle Recovery	86
Auto Power-off	79
Auto Power-on	79
Auto Remote	82
B	
Blowing fan	21, 108
C	
Cancel	26
Cap	91, 93, 105
Cap absorber	106
Capping station	20, 22
Carriage	20, 22, 91, 95
Carriage movement	26
Carriage Out	75
Cartridge weight	80
Case weight	80
Clamp lever	20, 21
Cleaning Check	74
Color profile	35
Connection relay cable	135, 136
Custody Wash	100
Custody Wash	75
Cutting slot	23
D	
DAS	72, 91, 96
DISCLAIMERS	5

FCC regulations	5
Interference	5
Display	26, 27
Display language	80
Drop.PosCorrect	28, 47, 63, 72
DRYING TIME	73
Drying/Exhaust FAN	79

E

[END/POWER] key	25, 26, 31
[ENTER] key	26
Error	26
Error History	87
Event Mail	81, 84

F

Feed Comp.	28, 47, 61, 72
Feed Speed	73
Feeding Before Cut	82
Feeding unit	21
FILL UP INK	76
[FUNCTION] key	26, 28

G

Grit rollers	20, 22
--------------------	--------

H

Head cleaning	26, 60
Head height	49
Heater	72
Height adjustment lever	49

I

Information menu	87
Ink cartridge case	80, 82
Ink discharge channel	91, 97
INK END	39, 83
Ink error	27
Ink IC chip	82
INK LVL END	83
INK LVL LOW	83
INK NEAR-END	83

Ink pack	82
Ink status	27
Ink status indicator lamp	23
Ink supply unit	20, 23
Inlet	30
Installation guide	35, 36, 37
Installation Space	15
<hr/> J <hr/>	
[JOG] key	26
Judgment Condition	86
<hr/> K <hr/>	
Key Buzzer	80
<hr/> L <hr/>	
LAN cable	32
LAN port	21
LANGUAGE	80
List	87
Local guidance	29
LOCAL mode	26, 27
Logical Seek	72
<hr/> M <hr/>	
Machine setup menu	79
Main power supply switch	21, 24, 30
Maintenance covers	20
Maintenance liquid cartridge	21
Maintenance menu	75
MAPS	74
Margin	73
Media	51
Media Detect	79
Media feed	26
Media hanger	53
Media holder	91, 99
Media Remain	79
Media sensor	21, 24, 91, 98
MENU mode	27
Mimaki driver	35
Move To Maint. Space	75

Move To Platen Right End	75
<hr/>	
N	
<hr/>	
NCU.....	22, 91, 94
Network	80
NOT-READY mode	27
Nozzle check menu	86
Nozzle Recovery	75
Nozzle Wash	120
Nozzle Wash	75
<hr/>	
O	
<hr/>	
Operating panel.....	20, 26
<hr/>	
P	
<hr/>	
Pinch rollers.....	20, 22, 108
Platen	20, 23, 91, 99
Post-heater	20
Power cable.....	30
Power outlet	30
Power plug	30
Preheater.....	21
Print Area	87
Print Length	87
Print origin	67
Printing Check	86
Pump Tube Cleaning.....	97
Pump Tube Cleaning.....	75
<hr/>	
R	
<hr/>	
RasterLink	35, 36, 37, 65, 66, 73
Receive buffer	68
Reference guide	66
Remaining ink.....	27
REMOTE mode	26, 27
Replace Wiper	103
Replace Wiper	75
Roll holder	53
Roll media	53
<hr/>	
S	
<hr/>	
Safety Interlocks.....	16

[SEL] key	26
SENSOR LEVEL	129
SENSOR LEVEL	122
Setup Menu	72
Smoothing Level.....	74
Space Btwn PP.	80
Space Feed Mode	80
Station	75
Status lamp	26
Switching hub	33
Symbols.....	7
SYSTEM HALT	26

T

Take-up SW	79
Take-up unit	20, 51
Take-up Unit.....	79
Test printing.....	26, 58
Time Set	80
Top blower.....	79
Torque limiter	52

U

UNIT / LENGTH.....	80
UNIT / TEMP	80
Usage	87
USB interface cable.....	32
USB port.....	21
Use Time	87

V

Vacuum fan	73
Version	87
View Feed	80

W

Warning Label	17
Waste ink tank.....	20, 76, 87, 91, 113
Waste Ink Tank	113
Wiper	91, 92, 103
Wiper cleaner	104
Wiping	87

MEMO



Operation manual

June, 2022

MIMAKI ENGINEERING CO.,LTD.

2182-3 Shigeno-otsu, Tomi-shi, Nagano 389-0512 JAPAN

D203528-14-20062022

